

# CATALOGO SCUOLA 23/24



DECATHLON

# INDICE



## SCUOLA DELL'INFANZIA E SCUOLA PRIMARIA

8

PSICOMOTRICITÀ	9
MOTRICITÀ	16
ACCESSORI SCUOLA	20
ARREDI	21
MATERIALE ALLENAMENTO	23
CALCIO	26
BASKET	28
PALLAVOLO	30
SPORT DI RACCHETTA	33
GIOCHI DI PRECISIONE	36
BASEBALL	38
RUGBY	40
PALLAMANO	42
FLOORBALL	44
SCHERMA	45
PREMIAZIONI SPORTIVE	46
ABBIGLIAMENTO PERSONALIZZABILE	48

## SCUOLA SECONDARIA DI PRIMO GRADO

CALCIO	53
PALLAVOLO	56
BASKET	60
RUGBY	64
PALLAMANO	66
PALLAPUGNO	70
SCACCHI	70
BOCCE	70
BASEBALL	71
TENNIS	72
PADEL	78
PICKLEBALL	81
TENNIS TAVOLO	82
BADMINTON	85
GINNASTICA	88
ATLETICA	92
ARCIERIA	96
GOLF	98
SCHERMA	100
FLOORBALL	102
TCHOUKBALL	103
JUDO / KARATE	104
MATERIALE ALLENAMENTO	106
ARREDI	110
PREMIAZIONI SPORTIVE	113
CONTENITORI	116
ADAPTED SPORT	118
ABBIGLIAMENTO PERSONALIZZABILE	120

## SCUOLA SECONDARIA DI SECONDO GRADO

ACCESSORI	125
CALCIO	130
PALLAVOLO	133
BEACH VOLLEY	136
PALLAMANO	138
BASEBALL	139
SPORT DI RACCHETTA	140
BADMINTON	146
BASKET	148
RUGBY	152
ARCIERIA	154
UNIHOCCY / FLOORBALL	156
ADAPTED SPORTS	158
HITBALL	160
KIN-BALL	161
ATLETICA	162
GINNASTICA	166
ABBIGLIAMENTO PERSONALIZZABILE	174

## MODULO D'ORDINE

178



**DECATHLON CLUB**

**PER LA TUA SCUOLA**

# PER GLI ISTITUTI SCOLASTICI CHE DESIDERANO AGEVOLARE LO SPORT!

**SCOPRI LA VASTA GAMMA DI ABBIGLIAMENTO PERSONALIZZATO  
ED ACCESSORI APPOSITAMENTE SELEZIONATI  
PER L'ATTIVITÀ SPORTIVA SCOLASTICA.**



## MODALITÀ DI ACQUISTO

- **TRAMITE PORTALE MEPA**, ci trovi con il nome DECATHLON ITALIA SRL
  - Effettua l'acquisto tramite Ordine Diretto (ODA) o invitaci ad una Negoziazione
  - Non trovi il prodotto che cerchi? Non c'è problema, lo carichiamo noi!
  - Scrivi a [ITACLUB@DECATHLON.COM](mailto:ITACLUB@DECATHLON.COM)
- **TRAMITE SITO** [DECATHLON.IT](https://www.decathlon.it)
  - Dopo aver creato un account e aver selezionato Scuola o Pubblica Amministrazione
  - Hai bisogno di aiuto? Contattaci al +39 3400653291
- **TRAMITE I NOSTRI ESPERTI SUL TERRITORIO**
  - Cerca l'agente di zona più vicino a te scrivendo a questa mail: [ITACLUB@DECATHLON.COM](mailto:ITACLUB@DECATHLON.COM)



## MODALITÀ DI PAGAMENTO

- **TRAMITE BONIFICO BANCARIO**, con pagamento differito a 30 gg
- **FATTURA ELETTRONICA** in regime di split payment





**DECATHLON CLUB**

**PER LA TUA SCUOLA**



## MODALITÀ DI CONSEGNA

- **DIRETTAMENTE A SCUOLA**  
o all'indirizzo indicato in fase di ordine
- **COMODAMENTE PRESSO UNO DEI NOSTRI NEGOZI**,  
sempre gratuitamente



## CONTATTI

- **UN TEAM DI ESPERTI SEMPRE AL TUO FIANCO!**  
Chiedi di essere contattato, senza impegno,  
inviando una mail a [ITA.CLUB@DECATHLON.COM](mailto:ITA.CLUB@DECATHLON.COM)  
e specificando la provincia da cui ci contatti,  
il nostro team si metterà subito in contatto con te.



## GIFT CARD

- **PREMIA I TUOI STUDENTI** con le nostre carte regalo

# CHIAMIAMO ALL'APPELLO TUTTI GLI SPORTIVI.



Acquista la Carta Regalo Decathlon e scegli quali attrezzature sportive comprare. Perché lo sport è sempre una bella lezione.

..... BISOGNO DI INFORMAZIONI? .....



[carte.regalo@decathlon.com](mailto:carte.regalo@decathlon.com)  
[carte.regalo.decathlon@pec.it](mailto:carte.regalo.decathlon@pec.it)



[carteregalobusiness.decathlon.it](http://carteregalobusiness.decathlon.it)



+39 346 80 67 0 32  
+39 347 16 00 9 84  
+39 346 95 66 3 78

**DECATHLON**

**RESTA SEMPRE AGGIORNATO  
SUI NOSTRI PRODOTTI  
VAI SULLA PAGINA  
DECATHLON CLUB  
E NON PERDERTI  
NESSUNA OFFERTA!**

**DISPONIBILI ORA ANCHE  
GLI ARREDI PER ESTERNO**





A young child with braided hair is standing in a playroom. The room features a large window in the background, a white cabinet, a white chair with a teddy bear, and various toys on the floor. The entire image is overlaid with a semi-transparent blue filter. The text 'SCUOLA DELL'INFANZIA E SCUOLA PRIMARIA' is written in large, white, bold, sans-serif capital letters across the middle of the image.

# SCUOLA DELL'INFANZIA E SCUOLA PRIMARIA



# PSICOMOTRICITÀ



**DOMYOS**  
**TAVOLA PER L'EQUILIBRIO**

Da 1 a 6 anni  
Cod. MePA [8645617](#)



**DOMYOS**  
**KIT EQUILIBRIO PER LA PSICOMOTRICITÀ**

Dai 2 anni  
Cod. MePA [8545074](#)



**DOMYOS**  
**PALLA IN SPUGNA**

Colori: Rosa/Blu  
Cod. MePA [8501325](#)



**DOMYOS**  
**TUNNEL PER PSICOMOTRICITÀ**

Misure: 2 x 75 cm  
Cod. MePA [8501326](#)



**DOMYOS**  
**TRAVE IN SCHIUMA**

Misure: 116 x 10 x 17 cm  
Cod. MePA [8582902](#)



**DOMYOS**  
**KIT PERCORSO IN SCHIUMA**

Cod. MePA [8613238](#)



**DOMYOS**  
**TAPPETINO BABY ROSSO**

Misure: 33 x 33 x 1,4 cm  
Cod. MePA [8501439](#)



**DOMYOS**  
**TAPPETINO BABY GRIGIO**

Misure: 33 x 33 x 1,4 cm  
Cod. MePA [8501437](#)



**DOMYOS**  
**TAPPETINO GINNASTICA PIEGHEVOLE E REVERSIBILE**

Misure: 147 x 175 x 1 cm  
Cod. MePA [8640619](#)

# PSICOMOTRICITÀ



**DOMYOS  
MINI TRAMPOLINO**

Cod. MePA [8753805](#)



**DOMYOS  
PALLINE GIOCOLERIA 55 MM**

Peso: 60 g

Cod. MePA [8734326](#)



**DOMYOS  
PALLINE GIOCOLERIA 65 MM**

Peso: 120 g

Cod. MePA [8734335](#)



**DOMYOS  
ANELLI GIOCOLERIA 32 CM X3**

Cod. MePA [8733621](#)



**DOMYOS  
PALLA PEANUT BALL BAMBINO**

Cod. MePA [8404940](#)



**DOMYOS  
YO-YO**

Colore: Rosso/giallo

Cod. MePA [8733592](#)



**DOMYOS  
CORDA PER SALTARE BAMBINO**

Colore: rosa

Cod. MePA [8545046](#)



**DOMYOS  
TAPPETINO GINNASTICA  
PIEGHEVOLE**

Misure: 180 x 78 x 3,5 cm

Cod. MePA [8574575](#)



**DOMYOS  
TRAMPOLINO BAMBINI CON  
CORDA E INSERTI ANTISCIVOLO**

Cod. MePA [8733593](#)



**DOMYOS**  
**PALLA PER EQUILIBRIO**

Cod. MePA [8733666](#)



**DOMYOS**  
**CERCHIO**

Misure: 65 / 75 / 85 cm

Cod. MePA [8547513](#)



**DOMYOS**  
**PALLA PER SALTARE**

Misure: 45 / 60 cm

Cod. MePA [8363520](#)



**DOMYOS**  
**ELASTICO PER SALTARE**

Cod. MePA [8192083](#)



**KUIMA**  
**PALLINE TENNIS SPUGNA**

Misura: 9cm

Cod. MePA [8582127](#)



**BTWIN**  
**BICI SENZA PEDALI BAMBINO**  
**BTWIN RUNRIDE 100**

Colore: bianco-nero

Misura: 10"

Cod. MePA [8576416](#)



**BTWIN**  
**BICI SENZA PEDALI BAMBINO**  
**RUNRIDE 900 (CON FRENO)**

Colore: gialla

Misura: 12"

Cod. MePA [8577585](#)



**KIPSTA**  
**SCALA DA ALLENAMENTO 3,2M**

Cod. MePA [8496478](#)



**KIPSTA**  
**SCALA DA ALLENAMENTO 3,2M**

Cod. MePA [8552079](#)

# PSICOMOTRICITÀ



**KIPSTA**  
**CINESINI X40**

Cod. MePA [8497806](#)



**OXELO**  
**CONI ROLLER X10**

Colori: Rosa/arancioni/celesti/verdi

Cod. MePA [8331859](#)



**KIPSTA**  
**CONI 30CM MODULARI X4**

Cod. MePA [8496471](#)



**KIPSTA**  
**ASTE 90CM PER CONI MODULARI**

Cod. MePA [8496468](#)



**GEOLOGIC**  
**BIRILLI DI CARTONE DA MONTARE**

Cod. MePA [8796545](#)



**GEOLOGIC**  
**BIRILLI FINLANDESI**

Cod. MePA [965493](#)



**GEOLOGIC**  
**BERSAGLIO E FRECCETTE SCRATCH**

Cod. MePA [8379654](#)



**GEOLOGIC**  
**GIOCO CORNHOLE COMPACT**

Cod. MePA [8775679](#)





**VIVISPORT**  
**SCALA PERCORSO**

Misura: 120 x 60 x 60 cm  
Cod. MePA [9503](#)

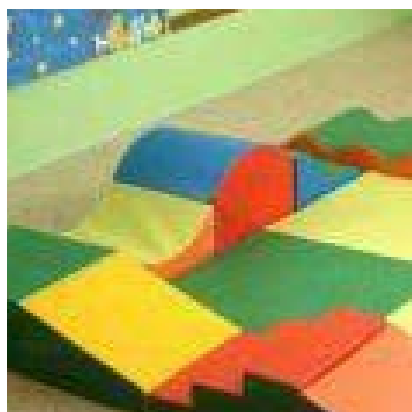

**VIVISPORT**  
**ONDA PERCORSO**

Misura: 120 x 60 x 60 cm  
Cod. MePA [9502](#)



**VIVISPORT**  
**SEMICILINDRO**

Misura: 120 x 60 x 60 cm  
Cod. MePA [9405](#)



**VIVISPORT**  
**DIVANETTO 3 POSTI**

Misura: 120 x 50 x 50 cm  
Cod. MePA [9561](#)



**VIVISPORT**  
**TAPPETONE PIEGHEVOLE**

Misura: 200 x 200 cm  
Cod. MePA [9555](#)

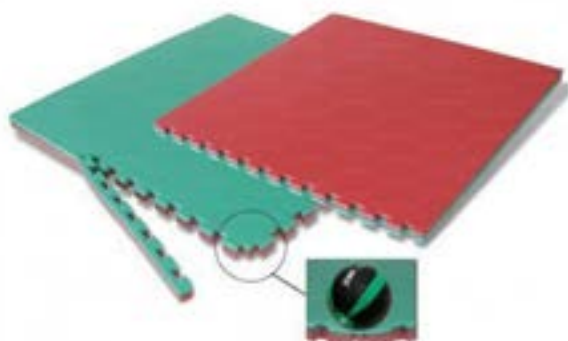

**VIVISPORT**  
**TAPPETO INCASTRO**

Misura: 100 x 100 x 2 cm  
Cod. MePA [8514394](#)



**VIVISPORT**  
**NUVOLA POUF**

Misura: 150 x 100 x 20 cm  
Cod. MePA [9516](#)

# PSICOMOTRICITÀ



**LAP**  
**KING GOAL**  
Cod. MePA [40023](#)



**LAP**  
**SET CARTELLI STRADALI**  
Cod. MePA [40052](#)



**LAP**  
**ROLLICOCQ**  
Cod. MePA [40004](#)



**LAP**  
**SCACCHI**  
Cod. MePA [40065](#)



**LAP**  
**DADO SPUGNA 16 CM**  
Cod. MePA [40302](#)



**LAP**  
**SET BOWLING**  
Cod. MePA [40307](#)



**LAP**  
**RUOTA MOTRICITÀ 40 CM**

Cod. MePA [40005](#)



**LAP**  
**RUOTA MOTRICITÀ 60 CM**

Cod. MePA [40006](#)



**LAP**  
**RUOTA MOTRICITÀ 76 CM**

Cod. MePA [40007](#)



**LAP**  
**SET 4 ROLLER BOARD**

Cod. MePA [42908](#)



**LAP**  
**SET 6 TRAMPOLI A SOFFIETTO**

Cod. MePA [42960](#)



**LAP**  
**ROTOCUBO**

Cod. MePA [60417](#)



# MOTRICITÀ



## ITALVENETA

### KIT "A"

Cod. MePA [102](#)



## ITALVENETA

### KIT "B"

Cod. MePA [103](#)



## ITALVENETA

### KIT "C"

Cod. MePA [104](#)



## ITALVENETA

### KIT "D"

Cod. MePA [105](#)



## ITALVENETA

### KIT "E"

Cod. MePA [106](#)



## ITALVENETA

### KIT PSICOMOTORIO "FANTASIA"

Cod. MePA [071](#)



## ITALVENETA

### SET BASE- KIT PSICOMOTORIO

Cod. MePA [108](#)



## ITALVENETA

### PERCORSO TUNNEL

Set 4 archi e 8 basi

Cod. MePA [140](#)



## ITALVENETA

### SALTARELLO GRANDE

Cod. MePA [094](#)





**ITALVENETA**  
**SALTARELLO PICCOLO**

Cod. MePA [095](#)



**ITALVENETA**  
**MULTISALTARELLO GRANDE**

Cod. MePA [096](#)



**ITALVENETA**  
**MULTISALTARELLO PICCOLO**

Cod. MePA [097](#)



**ITALVENETA**  
**PERCORSO EQUILIBRIO**

Cod. MePA [061](#)



**ITALVENETA**  
**PERCORSO EQUILIBRIO SCALA**

Set 16 blocchi + 32 ventose + 24 perni

Cod. MePA 183



**ITALVENETA**  
**MATTONI PERCORSO DRITTI**

Set 10 pz

Cod. MePA [059](#)



**ITALVENETA**  
**MATTONI PERCORSO CURVI**

Set 10 pz

Cod. MePA [060](#)



**ITALVENETA**  
**PERCORSO SEMISFERICO**

Set 24 pezzi

Cod. MePA [070](#)



**ITALVENETA**  
**ORME MOTORIE**

Set 22 mani + 22 piedi (sottili)

Cod. MePA 143

# MOTRICITÀ



## ITALVENETA

### LANCIA E SEGNA

Cod. MePA [120](#)



## ITALVENETA

### CASSETTA ASTE

Cod. MePA [121](#)



## ITALVENETA

### TUNNEL CERCHI

Cod. MePA [122](#)



## ITALVENETA

### SALTA/SALTA

Cod. MePA [124](#)



## ITALVENETA

### OSTACOLO JUMP

Cod. MePA [174](#)



## ITALVENETA

### PORTA ECONOMIC

con rete 165 x 120 cm

Cod. MePA [171](#)



## ITALVENETA

### CONTENITORE PER PALLONI E ALTRI OGGETTI

Completo di rete con tubolare 50 mm

Cod. MePA [137](#)



## ITALVENETA

### KIT PER PALESTRA

Completo di carrello

Cod. MePA [204](#)



## ITALVENETA

### SET 24 SEGNALI STRADALI IN PLASTICA CON BASE

Cod. MePA [036](#)



**ITALVENETA**  
**2 KIT EDUCAZIONE**  
**STRADALE - SET A**

Set 12 segnali stradali in plastica con base  
+ 1 semaforo h. 120 Cm  
Cod. MePA [202](#)



**ITALVENETA**  
**3 KIT EDUCAZIONE**  
**STRADALE - SET B**

Set 12 segnali stradali in plastica con base  
+ 1 semaforo h. 120 Cm  
Cod. MePA [203](#)



**ITALVENETA**  
**MATTONE GIGANTE 40 PEZZI**

Cod. MePA [008](#)



**ITALVENETA**  
**MATTONE GIGANTE**

Set 20 pezzi  
Cod. MePA [019](#)



**ITALVENETA**  
**SERIE 6 OSTACOLI MOBILI**

Altezze: 10 / 20 / 30 / 40 / 50 / 60 cm  
Cod. MePA 427



**ITALVENETA**  
**SERIE 3 OSTACOLI MOBILI**

Altezza: 60 cm  
Cod. MePA 428



**ITALVENETA**  
**SERIE 3 OSTACOLI MOBILI**

Altezza: 40 cm  
Cod. MePA 429



**ITALVENETA**  
**MATTONE GIGANTE**  
**ECO-FRIENDLY**

Set 40 pezzi  
Colore: Grigio scuro e marrone  
Cod. MePA [7008](#)



**ITALVENETA**  
**MATTONE GIGANTE**  
**ECO-FRIENDLY**

Set 20 pezzi  
Grigio scuro e marrone  
Cod. MePA [7019](#)



# ACCESSORI SCUOLA



**QUECHUA**  
**ZAINO MH100 5L**  
Cod. MePA [8588848](#)



**DOMYOS**  
**CAPPELLINO GINNASTICA 500  
REGOLABILE**  
Vari colori  
Cod. MePA [8786220](#)



**PERSONALIZZA  
CON NOI  
I TUOI PRODOTTI**

**QUECHUA**  
**BORRACCIA 900 ALLUMINIO 0,6L**  
Vari colori.  
Personalizzabile con adesivo  
Cod. MePA [8615531](#)



# ARREDI



**VIVISPORT**  
**PANCA SPOGLIATOIO**  
**SOLO SEDUTA**

Misura: 1 mt  
 Cod. MePA [8813884](#)



**VIVISPORT**  
**PANCA SPOGLIATOIO**  
**SOLO SEDUTA**

Misura: 2 mt  
 Cod. MePA [8805171](#)



**LAP**  
**LETTINO SCUOLA MATERNA**

Misura: 130 x 55 cm  
 Cod. MePA 42900

# ARREDI



## VIVISPORT APPENDIABITI ALLUMINIO

Misura: 1 mt  
Cod. MePA [8608](#)



## VIVISPORT APPENDIABITI PVC

Misura: 1 mt  
Cod. MePA [8632](#)



## VIVISPORT APPENDIABITI IN LEGNO

Misura: 1 mt  
Cod. MePA [9015](#)



## VIVISPORT APPENDIABITI ALLUMINIO

Misura: 2 mt  
Cod. MePA [8609](#)



## VIVISPORT APPENDIABITI PVC

Misura: 2 mt  
Cod. MePA [8633](#)



## VIVISPORT APPENDIABITI IN LEGNO

Misura: 2 mt  
Cod. MePA [9016](#)



## VIVISPORT PANCA SPOGLIATOIO CON SEDUTA, SCHIENALE, APPENDINI

Misura: 2 mt  
Cod. MePA [8799674](#)



## VIVISPORT ARMADIO METALLICO 2 POSTI

Cod. MePA [8807695](#)



# MATERIALE ALLENAMENTO





# MATERIALE ALLENAMENTO



**KIPSTA**  
**FISCHIETTO IN PLASTICA**

Cod. MePA [8027254](#)



**KIPSTA**  
**RETE PORTA PALLONI (10-14)**

Cod. MePA [8001768](#)



**KIPSTA**  
**SCALA DA ALLENAMENTO 3,2M**

Cod. MePA [8496478](#)



**KIPSTA**  
**SCALA DA ALLENAMENTO 3,2M**

Cod. MePA [8552079](#)



**KIPSTA**  
**CINESINI X40**

Cod. MePA [8497806](#)



**KIPSTA**  
**CONI 30CM MODULARI X4**

Cod. MePA [8496471](#)



**KIPSTA**  
**ASTE 90CM PER CONI MODULARI**

Cod. MePA [8496468](#)



**KIPSTA**  
**PETTORINE COLORATE**

Cod. MePA [8526951](#)



**KIPSTA**  
**CONTENITORE CHIUSO GRANDE**

Cod. MePA [8511619](#)



**KIPSTA**  
**CONTENITORE CHIUSO  
PIEGHEVOLE**

Cod. MePA [8398816](#)



**KIPSTA**  
**AGHI PER GONFIARE PALLONI**

Cod. MePA [8027171](#)



**KIPSTA**  
**POMPA PALLONI ESSENTIAL**

Cod. MePA [8556016](#)



**KIPSTA**  
**POCHETTE TATTICA ALLENATORE  
CALCIO**

Cod. MePA [8496481](#)



**DOMYOS**  
**CORDA PER SALTARE BAMBINO**

Misura: 240 cm. Colore: blu  
Cod. MePA [8667229](#)



**DOMYOS**  
**CORDA PER SALTARE BAMBINO  
500 REGOLABILE**

Misura: da 180 a 210 cm. Colore: azzurra  
Cod. MePA [8381642](#)

# ■ CALCIO

A photograph of two children playing soccer on a paved area in front of a school building. The image is overlaid with a blue tint. A girl in a dark shirt and pants is running towards the right, while a boy in a white shirt and dark pants is running towards the left, kicking a yellow and green soccer ball. The school building in the background has several windows and doors.





**KIPSTA**  
**PORTA CALCIO SG500**

3 taglie disponibili  
Cod. MePA [8767318](#)



**KIPSTA**  
**PORTA CALCIO GONFIABILE KAGE PUMP**

2 taglie disponibili  
Cod. MePA [8612752](#)



**KIPSTA**  
**PALLONE CALCIO FIRST KICK**

Taglia 3/4/5  
Cod. MePA [8676296](#)



**KIPSTA**  
**PALLONE MORBIDO SUNNY**

Taglia 4  
Cod. MePA [8753531](#)



**KIPSTA**  
**PALLONE CALCIO SPUGNA**

Colori: verde/blu  
Cod. MePA [960300](#)



# ■ BASKET





**TARMAK**  
**CANESTRO REGOLABILE B100**

Cod. MePA [8529807](#)



**TARMAK**  
**CANESTRO SK100**  
**DA APPENDERE AL MURO**

Cod. MePA [8734284](#)



**TARMAK**  
**CANESTRO SB100**  
**DA APPENDERE AL MURO**

Cod. MePA [960586](#)



**TARMAK**  
**MINIPALLONE BASKET K 100**

Taglia 1 giallo

Cod. MePA [8616153](#)



**TARMAK**  
**PALLONE BASKET R100**

Taglia 5 giallo

Cod. MePA [8547126](#)



**TARMAK**  
**PALLONE BASKET R100**

Taglia 7 arancione

Cod. MePA [8547127](#)



# ■ PALLAVOLO

A group of children are playing volleyball in a large indoor gymnasium. The scene is captured in a blue-tinted, high-angle shot. The children are scattered across the court, some in motion, others standing. A net is visible in the background. The gymnasium has high ceilings with exposed beams and several large windows. The floor is marked with yellow lines for the volleyball court.



**ALLSIX**  
**PALLONE PALLAVOLO V100 SOFT**

Peso: 260-280g  
Colore: blu-bianco  
Cod. MePA [8640987](#)



**ALLSIX**  
**PALLONE PALLAVOLO V100 SOFT**

Peso: 200/220 gr  
Pallone ufficiale Fipav  
Cod. MePA [8821112](#)



**ALLSIX**  
**PALLONE PALLAVOLO V 100 SOFT**

Peso: 230-250 gr.  
Colore: blu-arancione  
Pallone ufficiale Fipav  
Cod. MePA [8821113](#)



**MOLTEN**  
**PALLONE PALLAVOLO SOFT TOUCH SCHOOL**

Cod. MePA [3204346](#)



**MOLTEN**  
**PALLONE PALLAVOLO MINI VOLLEY**

Colore: giallo  
Cod. MePA [8513569](#)



**MOLTEN**  
**PALLONE PALLAVOLO 4000**

Cod. MePA [8132741](#)



**MIKASA**  
**PALLONE PALLAVOLO V300W**

Colore: giallo-blu  
Cod. MePA [8570790](#)

# PALLAVOLO



**ALLSIX**  
**KIT BEACH VOLLEY BV500 REGOLABILE**

Colore: giallo

Cod. MePA [8480571](#)



**ALLSIX**  
**BERSAGLIO ALLENAMENTO**  
**PALLAVOLO VNT900**

Cod. MePA [8554277](#)



**ALLSIX**  
**ASTE PALLAVOLO V900**

Cod. MePA [8408966](#)



**ALLSIX**  
**RETE PALLAVOLO V900**

Cod. MePA [8497189](#)



**ALLSIX**  
**CARRELLO PER PALLONI**  
**REGOLABILE VBB900**

Colore: blu

Cod. MePA [8552382](#)





# SPORT DI RACCHETTA

# SPORT DI RACCHETTA



**ITACLUB**  
**PALMARE IN**  
**LEGNO**

Cod. MePA [8664830](#)



**KUIMA**  
**RACCHETTA TENNIS**  
**JUNIOR TR100 19"**

Cod. MePA [8575253](#)



**KUIMA**  
**RACCHETTA TENNIS**  
**JUNIOR TR100 21"**

Cod. MePA [8575254](#)



**KUIMA**  
**RACCHETTA TENNIS**  
**JUNIOR TR100 23"**

Cod. MePA [8575255](#)



**KUIMA**  
**RETE TENNIS 3M**

Cod. MePA [8611323](#)



**KUIMA**  
**RETE TENNIS 5 METRI**

Cod. MePA [8655756](#)



**KUIMA**  
**PALLINE TENNIS TB100**  
**ROSSE X3**

(4-7 anni)

Cod. MePA [8588568](#)



**KUIMA**  
**PALLINE TENNIS TB110**  
**ARANCIONI X3**

(8-11 anni)

Cod. MePA [8588569](#)



**KUIMA**  
**KIT PING PONG 2**  
**RACCHETTE PPR 130 +**  
**3 PALLINE**

Cod. MePA [8352108](#)



**KUIMA**  
**RETE PING PONG**  
**ROLLNET**

Colore: blu-bianco

Cod. MePA [8501506](#)



**KUIMA**  
TAVOLO PING PONG  
PPT 130 SMALL INDOOR

Cod. MePA [8501776](#)



**KUIMA**  
TAVOLO PING PONG  
INDOOR TTT 110 BLU

Cod. MePA [8359414](#)



**KUIMA**  
KIT BADMINTON BAMBINO  
DISCOVER BR

Cod. MePA [8810907](#)



**KUIMA**  
KIT BADMINTON EASY SET 3M  
AZZURRO

Cod. MePA [8626192](#)

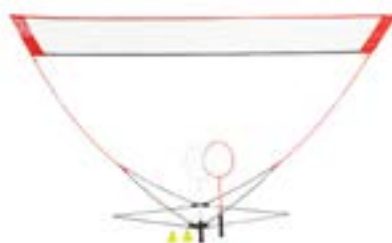

**KUIMA**  
KIT BADMINTON EASY SET  
DISCOVER ROSSO

Cod. MePA [8739838](#)



**KUIMA**  
KIT RACCHETTE BADMINTON  
BAMBINO BR 100 STARTER  
OUTDOOR

Cod. MePA [8750838](#)



**KUIMA**  
VOLANI BADMINTON OUTDOOR X3

Cod. MePA [8212072](#)



**KUIMA**  
TAMBURELLO SONORO 26 INDOOR  
BAMBINO

Cod. MePA [8527377](#)



**KUIMA**  
KIT SPEEDBALL TURNBALL

Colore: Nero-giallo  
Cod. MePA [8212072](#)



# GIOCHI DI PRECISIONE

The image is a vertical collage of four photographs, all tinted with a blue color. The top photo shows a woman in a striped shirt and dark shorts on a grassy lawn, preparing to throw a large, dark, spherical ball. The second photo from the top shows two young children, one taller and one shorter, both wearing patterned long-sleeved shirts, standing on a brick path and aiming bows. The third photo shows a person's legs and feet on a paved surface, performing a water bottle flip; a plastic bottle is in mid-air above a water bottle on the ground. The bottom photo shows a man in a light-colored shirt standing on a grassy area, looking towards a target set up on the ground, while another man in a dark t-shirt stands in the background.





**GEOLOGIC**  
**KIT TIRO CON L'ARCO**  
**SOFTARCHERY 100**

Cod. MePA [8505629](#)



**GEOLOGIC**  
**SET EASYTECH ROSSO**

Cod. MePA [8311056](#)



**GEOLOGIC**  
**BERSAGLIO TIRO CON L'ARCO**  
**DISCOVERY SOFT**

Cod. MePA [8486908](#)



**GEOLOGIC**  
**FRECCE TIRO CON L'ARCO DISCOSOFT VERDI X2**

Compatibili con arco Softarchery

Cod. MePA [8542931](#)

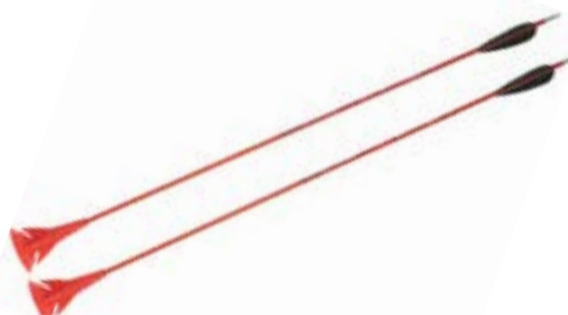

**GEOLOGIC**  
**FRECCE TIRO CON L'ARCO EASYSOFT ROSSE X2**

Compatibili con Easytech

Cod. MePA [8542932](#)



**GEOLOGIC**  
**BERSAGLIO TIRO CON L'ARCO**  
**FUNNY SOFTARCHERY 100**

Cod. MePA [8647341](#)



**CANAVERAL**  
**BERSAGLIO IN VELCRO**

Cod. MePA [8580634](#)



**GEOLOGIC**  
**BOCCE PÉTANQUE PLASTICA X8**

Cod. MePA [8245139](#)



# BASEBALL





**KIPSTA**  
**MAZZA BASEBALL JR**

Cod. MePA [8364655](#)



**KIPSTA**  
**KIT BASEBALL JR**

Cod. MePA [8407681](#)



**KIPSTA**  
**PALLA BASEBALL SCHIUMA**

Cod. MePA [8406139](#)



**KIPSTA**  
**GUANTONE LANCIATORE DESTRO**

Cod. MePA [8514084](#)



**KIPSTA**  
**GUANTONE LANCIATORE SINISTRO**

Cod. MePA [8514085](#)

# RUGBY





**OFFLOAD**  
**PALLONE TAGLIA 0**

Cod. MePA [8550605](#)



**OFFLOAD**  
**PALLONE SCHIUMA TAGLIA 3**

Cod. MePA [8640222](#)



**OFFLOAD**  
**PALLONE TAGLIA 3 GIALLO**

Cod. MePA [8496286](#)



**OFFLOAD**  
**PALLONE TAGLIA 4 ARANCIONE**

Cod. MePA [8496285](#)



**OFFLOAD**  
**PALLONE TRAINING TAGLIA 3**

Cod. MePA [8579039](#)



**OFFLOAD**  
**PALLONE TRAINING TAGLIA 4**

Cod. MePA [8579036](#)



**OFFLOAD**  
**PALLONE TRAINING TAGLIA 5**

Cod. MePA [8579041](#)



**OFFLOAD**  
**TEE RUGBY**

Cod. MePA [8520077](#)



**OFFLOAD**  
**KIT CINTURE FLAG RUGBY**

Cod. MePA [8496110](#)



A photograph of a handball game in progress, overlaid with a blue tint. A player in a dark jersey is jumping to catch a ball, while a player in a light blue jersey is reaching out to defend. A third player in a yellow jersey is visible in the background. A goal is visible behind the players.

# ■ PALLAMANO



**ATORKA**  
**PALLA BEACH TAGLIA 1**  
 Cod. MePA [8497541](#)



**ATORKA**  
**PALLAMA BEACH TAGLIA 2**  
 Cod. MePA [8497543](#)



**ATORKA**  
**PALLA BEACH TAGLIA 3**  
 Cod. MePA [8497545](#)



**ATORKA**  
**PALLA SOFT TAGLIA 0**  
 Cod. MePA [8554173](#)



**ATORKA**  
**PALLA SOFT TAGLIA 1**  
 Cod. MePA [8553803](#)





# FLOORBALL



**OROKS**  
**MAZZA JUNIOR 100**  
Cod. MePA [8406063](#)



**OROKS**  
**PALLA JUNIOR 100**  
Cod. MePA [8542237](#)



# SCHERMA



**NASYCON**  
**MASCHERA SCHERMA**  
**BAMBINO ROSSA**  
Cod. MePA [8623078](#)



**NASYCON**  
**MASCHERA SCHERMA**  
**BAMBINO BLU**  
Cod. MePA [8623077](#)



**NASYCON**  
**FIOMETTO IN PLASTICA BAMBINO**  
**NERO**  
Cod. MePA [8623079](#)

A hand holding a gold medal against a blue background. The medal is circular and features a figure, possibly a deity or a historical figure, surrounded by a laurel wreath. The background is a blurred blue scene with bokeh light effects.

# PREMIAZIONI SPORTIVE

**PERSONALIZZA  
CON NOI  
I TUOI PRODOTTI**



**ITACLUB  
MEDAGLIA ORO, ARGENTO E BRONZO**

Cod. MePA [8533942](#)



**ITA CLUB  
TARGA PICCOLA**

Cod. MePA [8571107](#)



**ITA CLUB  
TARGA MEDIA**

Cod. MePA [8571108](#)



**ITA CLUB  
COPPE**

Cod. MePA [8327138](#)



**ITA CLUB  
TARGA GRANDE**

Cod. MePA [8571109](#)



# ABBIGLIAMENTO PERSONALIZZABILE



## T-SHIRT R6554 BEAGLE

T-shirt manica corta, girocollo con collo doppio elastane. Taglie: 1/2 ANNI - 4XL. Composizione: 100% cotone, single jersey, 155 g/m<sup>2</sup>.



## FELPA CAPPUCCIO FULL ZIP R6421 MONTBLANC

Felpe stile casual con cappuccio. Cerniera lunga. Tasca a canguro. Polsini e girovita in costina 2x2 di elastane. Taglie: 3/4 ANNI - 3XL. Composizione: 50% cotone / 50% poliestere, interno felpato, 280 g/m<sup>2</sup>.



## POLO R6638 STAR

T-shirt manica corta, girocollo con collo doppio elastane. Taglie: 1/2 ANNI - 4XL. Composizione: 100% cotone, single jersey, 155 g/m<sup>2</sup>.



## FELPA CON CAPPUCCIO R1087 CAPUCHA

Regolabile. Tasche a marsupio. Collo, polsini e girovita in costina 1x1 con elastane. Modello bambino senza cordone. Taglie: 3/4 ANNI - 3XL. Composizione: 50% cotone / 50% poliestere, interno felpato, 280 g/m<sup>2</sup>.



- ANT. LAT. POST.
- 01
  - 02
  - 04
  - 05
  - 07
  - 08
  - 15
  - 16
  - 19
  - 22
  - 23
  - 24
  - 25
  - 26
  - 30
  - 34
  - 36
  - 37
  - 38
  - 46

**FELPA GIROCOLLO R1070 CLASSICA**

Felpe classica girocollo. Girocollo, polsini e girovita di elastane in costina 1x1. Copricuciture sul collo. Taglie: 1/2 ANNI - 3XL. Composizione: 50% cotone / 50% poliestere, interno felpato, 280 g/m².



- ANT. LAT. POST.
- 01
  - 07
  - 19
  - 21
  - 27
  - 31
  - 44

**PETTORINE UNISEX R0414 AJAX**

Taglie: 8 ANNI - XL. Composizione: 100% poliestere piquet, 140 g/m².



**CAPPELLINO BS600**

Berretto a 5 pannelli con chiusura in velcro, fascia anti-sudore in poliestere, occhielli cuciti, pannello frontale rigido, visiera precurvata. Taglia unica. Composizione: 100% Cotone. 100% Poliestere per i colori Fluo



- AR
- AZ
- BI
- BL
- FX
- GI
- NE
- RO
- RS
- RY
- VE
- VL
- WA
- WB
- WG
- WR
- WV
- WY
- WZ

**SACCA - ZAINO PG280**

Zaino multiuso in nylon. Doppia corda di chiusura, rinforzo negli angoli in contrasto. Misure: 33 x 45 cm. Composizione: 100% nylon.



- 01
- 05
- 17
- 04
- 09
- 00

**BORRACCIA ALLUMINIO BS890**

100% alluminio. Borraccia con tappo a vite e moschettone in alluminio. Capacità: 500 ml. Non isoterma. Può contenere bevande calde. Dimensioni: H 21 cm Diametro 6 cm.1

**DECATHLON CLUB**  
PER LA TUA SCUOLA

**CON I pon**  
**TI AIUTIAMO NOI:**  
**REALIZZA E**  
**PERSONALIZZA!**

Decathlon è vicino ai bisogni delle scuole italiane e ha costruito un'offerta apposita dedicata ai materiali e all'abbigliamento personalizzabile con i loghi ufficiali PON

# SCOPRI I PROGETTI GRATUITI DEDICATI A TE E AI TUOI STUDENTI: VAI SULLA PAGINA DECATHLON CLUB, SEZIONE SCUOLA, PROGETTI EDUCATIONAL



## CHIAMA ALL'APPELLO TUTTI GLI SPORTIVI: LO SPORT É SEMPRE UNA BELLA LEZIONE!

Il movimento migliora i processi di apprendimento: ecco perché si parla sempre più spesso di "Pause Attive", esperienze didattiche, pedagogiche che hanno confermato la loro efficacia, riconosciuta nel 2019 anche dal Ministero della Salute.

I benefici principali sono:

- 1) Aumento di attenzione. I minuti di attenzione possono passare da 10 fino a 30
- 2) Sviluppo all'auto-percezione dello stato fisico ed emotivo: gli alunni vengono alleggeriti senza arrivare agli estremi di cominciare a disturbare o chiedere di andare in bagno per strappare qualche minuto di pausa. Ciò li rende protagonisti e consapevoli che possono agire all'interno dell'aula per contribuire al benessere proprio e collettivo.
- 3) Diminuzione dello stress degli insegnanti e creazione di benessere e salute di tutto il circuito scolastico.
- 4) Consapevolezza motoria e promozione di attività fisica e sportiva benefica per lo sviluppo psicofisico in età evolutiva
- 5) Alfabetizzazione motoria consapevole per approcciare alle varie e diverse attività e discipline sportive utili nel percorso cognitivo, comportamentale, emotivo e sociale in età evolutiva.

### **Progetto "Vincere con il movimento consapevole" & "Move yourself"**

C.A.MO.® & Decathlon a supporto dei docenti della scuola materna e primaria, per una didattica consapevole attraverso il movimento.

Si inserisce in ambito scolastico il progetto formativo "Vincere con il movimento consapevole" seguito dal 2 livello "Move yourself", supporto didattico per docenti della scuola primaria e materna promosso dall'azienda Decathlon Italia in collaborazione con i Chinesiologi C.A.MO.®. Il progetto affronta temi legati all'alfabetizzazione motoria, ambientalismo attivo, riequilibrio posturale e inclusione delle disabilità, basi imprescindibili per il corretto sviluppo cognitivo dei/ delle bambini/e in età evolutiva e si pone l'obiettivo di creare un ponte tra i Laureati in scienze motorie e i docenti della scuola primaria, attraverso una didattica motoria consapevole, che possono applicare nelle loro lezioni grazie all' apprendimento di pause attive finalizzate a promuovere stili di vita corretti e la sportività negli adulti del domani.

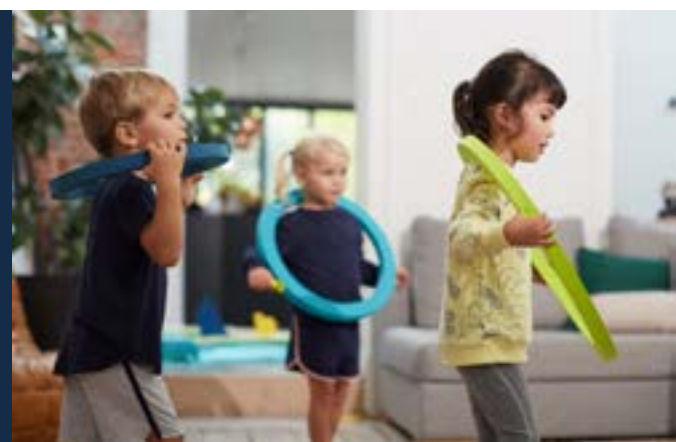



SCEGLI LA CARTA SCUOLA PIÙ ADATTA ALLE TUE ESIGENZE:  
**È SEMPLICE ED È GRATUITA!**

CARTA SCUOLA  
**BASIC**



CARTA SCUOLA  
**BASIC**

ACCUMULO PUNTI  
E BUONI  
TRAMITE ACQUISTI  
DIRETTI  
E DEI PROPRI  
AFFILIATI



CARTA SCUOLA  
**GOLD**

ACCUMULO PUNTI  
BUONI PER L'ACQUISTO DI  
ATTREZZATURE  
PROGETTI EDUCATIVI SOCIALI  
GRATUITI  
CASHBACK SU OGNI ACQUISTO  
SERVIZIO BANDI

CARTA SCUOLA  
**GOLD**

A photograph of three young boys playing soccer on an outdoor court. The scene is bathed in a warm, orange light, likely from a sunset or streetlights. The boy in the foreground is wearing a green t-shirt with the text 'STAY STRONG SOME' and 'WIKIPE' visible, and dark pants. He is running towards a green and yellow soccer ball. Two other boys are in the background, one in a white shirt and one in a yellow shirt. The background shows a building with windows and a door.

# SCUOLA SECONDIRIA DI PRIMO GRADO

# CALCIO



**KIPSTA**  
**MINI-PALLONE FUTSAL IN SCHIUMA**

Colore: BLU-LILLA  
Cod. MePA [8600233](#)



**KIPSTA**  
**MINI-PALLONE FUTSAL IN SCHIUMA**

Colore: ROSSO-BLU  
Cod. MePA [8600232](#)



**KIPSTA**  
**PALLONE FUTSAL IN SCHIUMA**

Taglia: 3, Colore: VERDE  
Cod. MePA [960300](#)



**KIPSTA**  
**PALLONE FUTSAL IN SCHIUMA**

Taglia: 3, Colore: ROSSO  
Cod. MePA [960301](#)



**KIPSTA**  
**PALLONE FUTSAL FS100 58CM**

Taglia: 3  
Cod. MePA [8563502](#)



**KIPSTA**  
**PALLONE FUTSAL**

Taglia: 4, Colore: ROSSO-BIANCO  
Cod. MePA [8773833](#)



**SELECT**  
**PALLONE FUTSAL ATTACK LIGHT**

Cod. MePA [8292348](#)



**KIPSTA**  
**PALLONE CALCIO SUNNY 300**

Taglia: 1, Colore: ROSA  
Cod. MePA [8753526](#)



**KIPSTA**  
**PALLONE CALCIO SUNNY 300**

Taglia: 1, Colore: TURCHESE  
Cod. MePA [8753527](#)



# CALCIO



**KIPSTA**  
**PALLONE CALCIO FIRST KICK**

Taglia: 5. Colore: GIALLO  
Cod. MePA [8676298](#)

---



**KIPSTA**  
**PALLONE CALCIO FIRST KICK**

Taglia: 4. Colore:ROSSO  
Cod. MePA [8676297](#)

---



**KIPSTA**  
**PALLONE CALCIO FIRST KICK**

Taglia: 3. Colore:BLU  
Cod. MePA [8676296](#)

---



**KIPSTA**  
**PALLONE CALCIO SUNNY 300**

Taglia: 4. Colore: VERDE  
Cod. MePA [8753532](#)

---



**KIPSTA**  
**PALLONE CALCIO SUNNY 300**

Taglia: 4. Colore: ARANCIONE  
Cod. MePA [8753531](#)

---



**KIPSTA**  
**PALLONE CALCIO IBRIDO F500**

Taglia: 3. Colore: BIANCO-GIALLO  
Cod. MePA [8619226](#)

---



**KIPSTA**  
**PALLONE CALCIO IBRIDO F500**

Taglia: 4. Colore: BIANCO-GIALLO  
Cod. MePA [8619223](#)

---



**KIPSTA**  
**PALLONE CALCIO IBRIDO F500**

Taglia: 5. Colore: ROSSO  
Cod. MePA [8619219](#)

---



**KIPSTA**  
**PALLONE CALCIO IBRIDO F500**

Taglia: 5. Colore: BIANCO-GIALLO  
Cod. MePA [8619218](#)

---



**VIVISPORT**  
PORTE 3X2 ACCIAIO  
TRASPORTABILI

Cod. MePA [8582232](#)

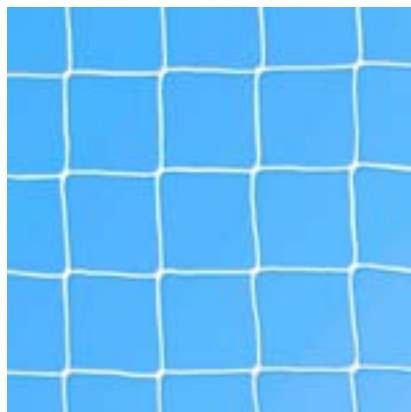

**VIVISPORT**  
RETE 300X200 CALCETTO QUADRA

Cod. MePA [8409357](#)



**KIPSTA**  
PORTA CALCIO SG 500

Taglia: S. Colore: blu-rosso

Cod. MePA [8767318](#)



**KIPSTA**  
PORTA CALCIO SG 500

Taglia: M. Colore: blu-arancione

Cod. MePA [8767321](#)



**KIPSTA**  
PORTA CALCIO CLASSIC 500

Taglia: L. Colore: blu-arancione

Cod. MePA [8602038](#)



**VIVISPORT**  
PORTE 3X2 CALCETTO LEGA  
TRASPORTABILI

Cod. MePA [8762773](#)



**KIPSTA**  
RETE 10-14 PALLONI

Cod. MePA [8001768](#)



**KIPSTA**  
SACCA PER 16 PALLONI NERA

Cod. MePA [8562384](#)





# ■ PALLAVOLO

A photograph of a volleyball game in progress. A player in a green jersey is in the foreground, jumping high to hit the ball with her right hand. Other players in green and red jerseys are visible on the court. The gymnasium has a wooden floor and a high ceiling with lights. The overall color scheme is warm and orange-toned.



**ALLSIX****PALLONE PALLAVOLO V100 SOFT**

Colore: blu-arancione

**Pallone Ufficiale Fipav**Cod. MePA [8821113](#)**ALLSIX****PALLONE PALLAVOLO V 100 SOFT**

Colore: blu-giallo. Peso: 200/220 Gr

**Pallone Ufficiale Fipav**Cod. MePA [8821112](#)**MOLTEN****PALLONE SOFT TOUCH SCHOOL**Cod. MePA [3204346](#)**MOLTEN****PALLONE PALLAVOLO 4000**Cod. MePA [8132741](#)**COPAYA****PALLONE BEACH VOLLEY BV 100 CLASSIC**

Taglia: 4. Colore: Verde

Cod. MePA [4337106](#)**MIKASA****PALLONE PALLAVOLO V300W**

Colore: Giallo-Blu

Cod. MePA [8570790](#)**MIKASA****PALLONE PALLAVOLO V200W**

Colore: Blu-Giallo

Cod. MePA [8570789](#)**ALLSIX****RETE PALLAVOLO V900**Cod. MePA [8497189](#)**ALLSIX****ASTE PALLAVOLO V900**Cod. MePA [8408966](#)

# PALLAVOLO



## VIVISPORT RETI MOBILI PORTA ANTENNE

Cod. MePA [8348068](#)



## VIVISPORT RETE PALLAVOLO TRAINING

Cod. MePA [8347987](#)



## COPAYA RETE BEACH-VOLLEY BV500 REGOLABILE

Cod. MePA [8480571](#)



## VIVISPORT ANTENNE PER RETI PALLAVOLO

Cod. MePA [8347990](#)



## VIVISPORT PALCHETTO PER ARBITRO RICHIUDIBILE

Cod. MePA [8762768](#)



## ALLSIX CARRELLO PER PALLONI REGOLABILE VBB900 BLU

Cod. MePA [8552382](#)



## VIVISPORT SEGNAPUNTI VOLLEY

Cod. MePA [8400902](#)



## VIVISPORT CONTENITORE CHIUSO PIEGHEVOLE

Cod. MePA [8398816](#)



## VIVISPORT SOSTEGNI PALI DA TERRENO

Cod. MePA [8404344](#)



**VIVISPORT**  
**CONTENITORE APERTO**  
**PIEGHEVOLE**

Cod. MePA [8540662](#)



**ALLSIX**  
**BERSAGLIO ALLENAMENTO**  
**PALLAVOLO VNT900**

Cod. MePA [8554277](#)



**LEGAR**  
**LAVAGNA VOLLEY PICCOLA**

Misura: 40 x 23 cm

Cod. MePA [100003](#)



**VIVISPORT**  
**IMPIANTO VOLLEY-MINIVOLLEY**

Cod. MePA [8377912](#)



**VIVISPORT**  
**MEGAFONO AMPLIFICATO MOD.**  
**CAROL**

Cod. MePA [8793124](#)



**BARRET**  
**CONTENITORE PIEGHEVOLE 60X60**

Cod. MePA [8820028](#)



**LEGAR**  
**SEGNAPUNTI VOLLEY SCOLASTICO**  
**0/30**

Cod. MePA 222800



**LEGAR**  
**CONTENITORE APERTO ZINCATO**  
**PIE. 60 X 60 X 90 H**

Cod. MePA [8540662](#)



TARMAK

# BASKET





**TARMAK**  
**PALLONE BASKET R100**

Taglia: 5  
Colore: GIALLO  
Cod. MePA [8547126](#)



**TARMAK**  
**PALLONE BASKET R100**

Taglia: 7  
Colore: Arancione  
Cod. MePA [8547127](#)



**TARMAK**  
**PALLONE BASKET BT100**

Taglia: 5  
Colore: Arancione  
Cod. MePA [8495715](#)



**TARMAK**  
**PALLONE BASKET BT100**

Taglia: 6  
Colore: Arancione  
Cod. MePA [8495716](#)



**TARMAK**  
**PALLONE BASKET BT100**

Taglia: 7  
Colore: Arancione  
Cod. MePA [8495726](#)



**TARMAK**  
**PALLONE BASKET RESIST 500**

Taglia: 5  
Colore: Blu  
Cod. MePA [8618531](#)



# BASKET



**TARMAK**  
**BORSA BASKET PER 5 PALLONI**

Cod. MePA [8407166](#)



**TARMAK**  
**CERCHIO BASKET 500 ROSSO**

Cod. MePA [8395749](#)

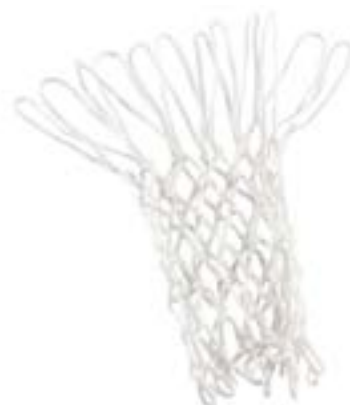

**TARMAK**  
**RETE BASKET 6MM BIANCA**

Resistente alle intemperie

Cod. MePA [8019129](#)



**TARMAK**  
**CANESTRO BASKET DA MURO**  
**SB700**

Cod. MePA [8547161](#)



**TABELLONE IN LEGNO BILAMINATO**

Cod. MePA [8802932](#)

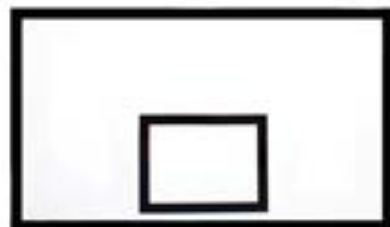

**TABELLONE IN RESINA**  
**MELAMINICA**

Misura: 180 X 120 CM.

Cod. MePA [8765521](#)





**TARMAK  
CANESTRO BASKET B100 EASY**

Canestro regolabile senza attrezzi  
Cod. MePA [8529815](#)



**SET BASKIN**  
Cod. MePA [F126BSK](#)



**PROTEZIONE ANTINFORTUNISTICA  
PER IMPIANTO BASKET MONOTUBO**

Spessore: 3 cm  
Cod. MePA [8778220](#)



**MEZZO IMPIANTO BASKET**

Mobile e regolabile  
Cod. MePA [8396296](#)



**CANESTRO BASKET B700 PRO**

Canestro regolabile senza attrezzi  
Misure: da 2,40m a 3,05m  
Cod. MePA [8529820](#)



**SEGNAPUNTI DA TAVOLO BASKET**

Cod. MePA [8391181](#)



# ■ RUGBY



**KIPSTA**  
**PALLONE RUGBY**

Taglia: 3  
Colore: GIALLO  
Cod. MePA [8496286](#)



**KIPSTA**  
**PALLONE RUGBY**

Taglia: 4  
Colore: ARANCIONE  
Cod. MePA [8496285](#)



**KIPSTA**  
**PALLONE RUGBY R500**

Taglia: 4  
Colore: ROSSO  
Cod. MePA [8579050](#)



**KIPSTA**  
**KIT CINTURE FLAG RUGBY R500**

Colore: BLU-ROSSO  
Cod. MePA [8496110](#)



**SANDEVER**  
**FLYING DISC D175 ULTIMATE**

Colore: BIANCO  
Cod. MePA [8590276](#)



**SANDEVER**  
**FLYING DISC D175 ULTIMATE**

Colore: BLU  
Cod. MePA [8796065](#)





# PALLAMANO

A photograph of a handball game in progress inside a gymnasium. The scene is bathed in a warm, orange light. In the center, a young boy in a dark jersey and light shorts is crouching, holding a handball with both hands, ready to pass or shoot. To his left, another player in a similar uniform is also crouching. In the background, a girl in a dark jersey and light shorts stands watching. The gymnasium has a high ceiling with a complex red metal truss structure. The walls are covered in a grid of small, square tiles, and there are red doors or lockers visible in the background. The floor is a polished wooden surface.



**ATORKA**  
**PALLA PALLAMANO H100 SOFT**

Taglia: 1. Colore: BLU-ARANCIONE  
Cod. MePA [8553803](#)



**ATORKA**  
**PALLA PALLAMANO IBRIDA H500**

Taglia: 1. Colore: BLU-BIANCO  
Cod. MePA [8669625](#)



**ATORKA**  
**PALLA PALLAMANO IBRIDA H500 T2**

Taglia: 2. Colore: BLU-BIANCO  
Cod. MePA 8669631



**ATORKA**  
**PALLA PALLAMANO BEACH HB500B**

Taglia: 2. Colore: ROSSA  
Cod. MePA [8497543](#)



**ATORKA**  
**PALLA PALLAMANO BEACH HB500B**

Taglia: 2. Colore: GIALLA  
Cod. MePA [8497541](#)



**ATORKA**  
**PALLA PALLAMANO H900**

Taglia: 3. Colore: GRIGIO-BIANCO  
Cod. MePA [8569814](#)



**SELECT**  
**PALLA PALLAMANO SELECT ATECA**

Taglia: 2. Colore: BLU-VERDE  
Cod. MePA [8854507](#)





# PALLAMANO



**LEGAR**  
**PALL.HANDBALL GOMMA TRIAL**  
**ULT30.3 F2**  
Cod. MePA 100089



**LEGAR**  
**PALL.HANDBALL GOMMA TRIAL**  
**V29 J1**  
Cod. MePA [100091](#)



**LEGAR**  
**PALL.HANDBALL GOMMA TRIAL**  
**V30 F2**  
Cod. MePA 100092



**LEGAR**  
**PALL.MINI HANDBALL TRIAL SOFT**  
**BA 0**  
Cod. MePA 100093



**LEGAR**  
**PALL.HANDBALL TRIAL SOFT BA29**  
**JUNIOR 1**  
Cod. MePA 100094



**LEGAR**  
**PALL.HANDBALL TRIAL SOFT BA25**  
**GR 150**  
Cod. MePA 100095



**LEGAR**  
**PALL.MICRO HANDBALL TRIAL SH1**  
Cod. MePA 180700



**TRIAL**  
**AIR BALL TRIAL Ø CM.12 GR.100**  
Cod. MePA [8800728](#)



**MONDO ITALIA**  
**PALLAPUGNO FIPAP**  
Cod. MePA [8802914](#)





**KIPSTA**  
**SACCA PER 8 PALLONI**

Cod. MePA [8562385](#)



**KIPSTA**  
**SACCA PER 16 PALLONI**

Cod. MePA [8562384](#)



**TRIAL**  
**PALLONE PALLAMANO SUPERSOFT**  
**E SICURO FEMM.**

Taglia: 2

Cod. MePA [8833082](#)

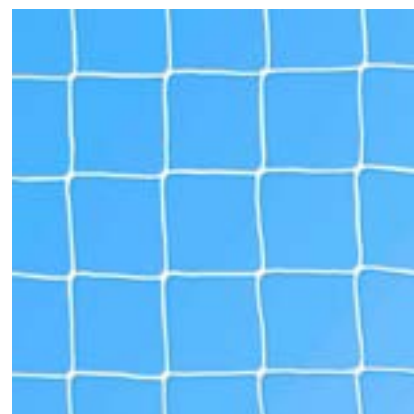

**VIVISPORT**  
**RETE 300x200 QUADRA**

Cod. MePA [8409357](#)



**VIVISPORT**  
**PORTE PALLAMANO MOBILI**

Cod. MePA [8762774](#)

# PALLAMANO



**BARRET**  
**SET 6+6 BOCCE SOFT TRIAL +**  
**PALLINO + SACCA**  
Cod. MePA [8849788](#)

---



# BOCCE



# PALLAPUGNO

**BARRET**  
**PALLONE PALLA PUGNO LEGGERA**  
Cod. MePA [8802914](#)

---



**LAP**  
**SCACCHI DA GIARDINO**  
Cod. MePA [40068](#)

---



# SCACCHI





# BASEBALL



**MAZZA BASEBALL SUPERSOFT**

Cod. MePA [TMB01](#)



**SET 7 PALLE BASEBALL/SOFBALL**

Cod. MePA [BSB.8](#)



**BATTING TEE TRIAL**

Cod. MePA [T21063](#)



# TENNIS





**KUIMA**  
**PALLINA BABY TENNIS TB130**  
**LILLA**

Cod. MePA [8338128](#)



**KUIMA**  
**PALLINE TENNIS IN SCHIUMA**  
**TB100 ROSA X2**

Cod. MePA [8546238](#)



**KUIMA**  
**PALLINE TENNIS IN SCHIUMA**  
**TB100 AZZURRE X2**

Cod. MePA [8546239](#)



**KUIMA**  
**PALLINE TENNIS TB160**  
**GIALLE X60**

Cod. MePA [8771793](#)



**KUIMA**  
**PALLINE TENNIS IN SCHIUMA**  
**TB100 ROSSE X2**

Cod. MePA [8582127](#)



**KUIMA**  
**PALLINE TENNIS IN SCHIUMA**  
**TB100 VERDI X2**

Cod. MePA [8582128](#)



**KUIMA**  
**PALLINE TENNIS TB100**  
**ROSSE X36**

Cod. MePA [8771786](#)



**KUIMA**  
**PALLINE TENNIS COMFORT GIALLE**  
**X 4**

Cod. MePA [8751046](#)



**KUIMA**  
**PALLINE TENNIS COMFORT GIALLE**  
**18 TUBI X 4**

Cod. MePA [8800132](#)

# TENNIS



**KUIMA**  
**PALLINE TENNIS TB110**  
**GIALLE X 3**

Cod. MePA [8573118](#)



**KUIMA**  
**PALLINE TENNIS COMFORT PRO**  
**GIALLE X4**

Cod. MePA [8646329](#)



**KUIMA**  
**PALLINE TENNIS COMFORT PRO**  
**GIALLE 2X4**

Cod. MePA [8800130](#)



**KUIMA**  
**PALLINE TENNIS COMFORT PRO**  
**GIALLE 18X4**

Cod. MePA [8800133](#)



**KUIMA**  
**PALLINE TENNIS TB930**  
**GIALLE X4**

Cod. MePA [8279042](#)



**KUIMA**  
**PALLINE TENNIS TB930**  
**GIALLE 2X4**

Cod. MePA [8576144](#)



**KUIMA**  
**PALLINE TENNIS TB930**  
**GIALLE 18X4**

Cod. MePA [8525460](#)



**KUIMA**  
**RETE PER 60 PALLINE DA TENNIS**

Cod. MePA [8013705](#)



**KUIMA**  
**MURO ALLENAMENTO TENNIS**

Cod. MePA [8648854](#)





**KUIMA**  
**CESTO PER 60 PALLINE DA TENNIS**

Colore: NERO

Cod. MePA [8641526](#)



**KUIMA**  
**RETE TENNIS 3 M**

Cod. MePA [8611323](#)



**KUIMA**  
**CESTO PER PALLINE DA TENNIS**

Cesto con rotelle, regolabile in altezza e ripiegabile.

Cod. MePA [962547](#)



**KUIMA**  
**RETE TENNIS 6 M**

Cod. MePA [8583475](#)



**KUIMA**  
**TUBO RACCATTAPALLE**

Cod. MePA [8665678](#)



**KUIMA**  
**LINEE DELIMITAZIONE X6**

Cod. MePA [8665676](#)



**TUBO+**  
**PRESSURIZZATORE**  
**PALLINE CRYSTAL**

Cod. MePA [8807364](#)

# TENNIS



**KUIMA**  
**REGOLATORE RETE TENNIS**

Cod. MePA [8071204](#)



**KUIMA**  
**ACCESSORIO APPRENDIMENTO**

Cod. MePA [8603781](#)



**KUIMA**  
**RACCHETTA TENNIS ADULTO**  
**TR100 NERA**

Cod. MePA [8351925](#)



**KUIMA**  
**RACCHETTA TENNIS ADULTO**  
**TR160 LITE AZZURRA**

Cod. MePA [8489539](#)



**KUIMA**  
**RACCHETTA TENNIS JUNIOR**  
**TR530 23**

Cod. MePA [8540239](#)



**KUIMA**  
**RACCHETTA TENNIS JUNIOR**  
**TR530 25**

Cod. MePA [8540248](#)



**KUIMA**  
**RACCHETTA TENNIS JUNIOR**  
**TR530 26"**

Cod. MePA [8540252](#)



**KUIMA**  
**OVERGRIP TENNIS COMFORT X3**

Cod. MePA [8587841](#)



**KUIMA**  
**GRIP TENNIS COMFORT NERO**

Cod. MePA [8340511](#)



**KUIMA**  
**CONI DELIMITAZIONE CAMPO DA**  
**TENNIS X12**

Cod. MePA [8330435](#)



**KUIMA**  
**SACCA PORTASCARPE ARANCIONE**

Cod. MePA [8378097](#)



**KUIMA**  
**SACCA PORTASCARPE**  
**NERA**

Cod. MePA [8378098](#)



**KUIMA**  
**CONFEZIONE 6 CONI**

Altezza 19cm e diametro 14cm

Cod. MePA [8330434](#)



**KUIMA**  
**RETE TENNIS COMPETITION**

Cod. MePA [8583474](#)



**KUIMA**  
**RETE TENNIS ESSENTIAL**

Cod. MePA [8013701](#)





# PADEL

THE



**KUIKMA**  
**RACCHETTA PADEL PR120 LIGHT**  
**ARANCIONE 325G**

Cod. MePA [8800445](#)



**KUIKMA**  
**RACCHETTA PADEL PR190 LIGHT**  
**BLU 310G**

Cod. MePA [8601310](#)



**KUIKMA**  
**RACCHETTA PADEL PR900 POWER**  
**LIGHT ROSSA 350-360G**

Cod. MePA [8650406](#)



**KUIKMA**  
**RACCHETTA PADEL PR900 POWER**  
**LIGHT AZZURRA 350-360G**

Cod. MePA [8754769](#)



**KUIKMA**  
**RACCHETTA PADEL PR560 LIGHT**  
**AZZURRA 330G**

Cod. MePA [8734651](#)



**HEAD**  
**RACCHETTA PADEL HEAD JUNIOR**  
**ALPHA SANYO 320G**

Cod. MePA [8664835](#)



**BULLPADEL**  
**RACCHETTA PADEL JUNIOR**  
**BULLPADEL HACK 335-345G**

Cod. MePA [8818998](#)



**KUIKMA**  
**RACCHETTA PADEL ADULTO PR530**  
**AZZURRO 340G**

Cod. MePA [8584913](#)



**KUIKMA**  
**PALLINE PADEL PB CONTROL X3**

Cod. MePA [8750703](#)

# PADEL



**KUIKMA**  
**PALLINE PADEL PB CLUB X3**  
Cod. MePA [8806720](#)

---



**KUIKMA**  
**PALLINE PADEL PB CLUB 18X4**  
Cod. MePA [8806716](#)

---



**KUIKMA**  
**PALLINE PADEL PB SPEED X3**  
Cod. MePA [8788980](#)

---



**HEAD**  
**TRIPACK PALLINE PADEL HEAD CLUB**  
Cod. MePA [8397246](#)

---



**KUIKMA**  
**OVERGRIP PADEL MULTICOLORE X28**  
Cod. MePA [8405532](#)

---



**FIPT**  
**TAMBURELLO SONORO 28 POLLICI INDOOR**  
Cod. MePA [8527371](#)

---



**FIPT**  
**TAMBURELLO AFONO 28 POLLICI**  
Cod. MePA [8527395](#)

---



**FIPT**  
**TAMBURELLO SONORO 26 INDOOR JR**  
Cod. MePA [8527377](#)

---



# PICKLEBALL



**KUIMA**  
**RACCHETTA**  
**PICKLEBALL 100 NERA**

Cod. MePA [8767131](#)



**KUIMA**  
**RACCHETTA PICKLEBALL**  
**500 AZZURRA**

Cod. MePA [8767140](#)



**KUIMA**  
**PALLINA PICKLEBALL**  
**BIANCA**

Cod. MePA [8373122](#)



**KUIMA**  
**KIT 2 RACCHETTE**  
**PICKLEBALL**

Cod. MePA [8371855](#)

# TENNIS TAVOLO





## KUIMA

**PALLINE PING PONG FB 830+ 1\*  
40+ BIANCHE X72**

Cod. MePA [2354022](#)



## KUIMA

**RACCHETTA PING PONG PPR 100  
0 GRIGIA**

Cod. MePA [8558628](#)



## KUIMA

**RACCHETTA PING PONG PPR 130 0  
NERO-ROSSO**

Cod. MePA [8558625](#)



## KUIMA

**RACCHETTA PING PONG PPR 100**

Cod. MePA [8286996](#)



## KUIMA

**RACCHETTA PING PONG PPR 130**

Cod. MePA [8042506](#)



## KUIMA

**RACCHETTA PING PONG TTR 100  
3\* ALLROUND**

Cod. MePA [8546785](#)



## KUIMA

**KIT PING PONG 2 RACCHETTE E 2  
PALLINE ROLLNET BIANCO-GRIGIO**

Cod. MePA [8548107](#)



## KUIMA

**RETE PING PONG PPN 183CM**

Cod. MePA [1097965](#)



## KUIMA

**RETE PING PONG NET 155CM**

Cod. MePA [8357775](#)



# TENNIS TAVOLO



**KUIMA**  
**RETE PING PONG ROLLNET**  
**BLU-BIANCO**

Cod. MePA [8501506](#)

---



**KUIMA**  
**TAVOLO PING PONG TTT 100**

Cod. MePA [8555782](#)

---



**KUIMA**  
**TAVOLO PING PONG PPT 500 OUTDOOR BLU**

Cod. MePA [8583712](#)

---



**TEQ LITE – TAVOLO TEQBALL**

Cod. MePA [8802901](#)

---

# BADMINTON



# BADMINTON



**KUIMA**  
**RACCHETTA**  
**BADMINTON JUNIOR**  
**BR160 EASY GRIP**

Colore: AZZURRA  
Cod. MePA [8548365](#)



**KUIMA**  
**RACCHETTA**  
**BADMINTON JR BR500**

Colore: NERO-GIALLO  
Cod. MePA [8490826](#)



**KUIMA**  
**RACCHETTA BADMINTON**  
**JR BR 560 LITE**

Colore: BIANCA  
Cod. MePA [8647934](#)



**BABOLAT**  
**EXPLORER II**  
**RACCHETTA BADMINTON**  
**ADULTO NANOFIARE**

Colore: AZZURRA  
Cod. MePA [8746602](#)

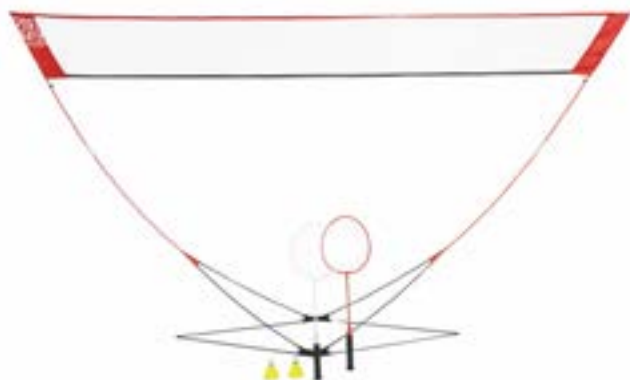

**KUIMA**  
**KIT BADMINTON EASY SET DISCOVER**

Colore: ROSSO  
Cod. MePA [8739838](#)



**KUIMA**  
**DELIMITAZIONI CAMPO**  
**BADMINTON GIALLE**

Cod. MePA [8373439](#)



**VIVISPORT**  
**IMPIANTO BADMINTON**  
**REGOLAMENTARE**

Coppia pali autoreggenti in acciaio  
Cod. MePA [8377913](#)



**KUIMA**  
**VOLANI BADMINTON**  
**PSC 100**

Cod. MePA [8590063](#)



**KUIMA**  
**VOLANI BADMINTON**  
**PSC 100 MEDIUM X6**

Colore: GIALLI  
Cod. MePA [8590058](#)



**KUIMA**  
**VOLANI BADMINTON**  
**FSC 560 X12**

Cod. MePA [8490803](#)



**KUIMA**  
**VOLANI BADMINTON**  
**OUTDOOR X3**

Cod. MePA [8212072](#)





**KUIMA**  
**VOLANI BADMINTON**  
**PSC 500 MEDIUM X6**

Colore: GIALLI  
Cod. MePA [8490797](#)



**YONEX**  
**VOLANI BADMINTON**  
**YONEX MAVIS 300 X6**

Colore: BIANCHI  
Cod. MePA [3309865](#)



**YONEX**  
**VOLANI BADMINTON**  
**YONEX MAVIS 600 X6**

Colore: BIANCHI  
Cod. MePA [8381640](#)



**KUIMA**  
**GRIP BADMINTON**  
**COMFORT X1**

Colore: NERO  
Cod. MePA [8552628](#)



**KUIMA**  
**RETE BADMINTON**

Colore: MARRONE  
Cod. MePA [8490770](#)



**KUIMA**  
**RETE BADMINTON**  
**COMPETITION NET**

Colore: NERA  
Cod. MePA [8490775](#)

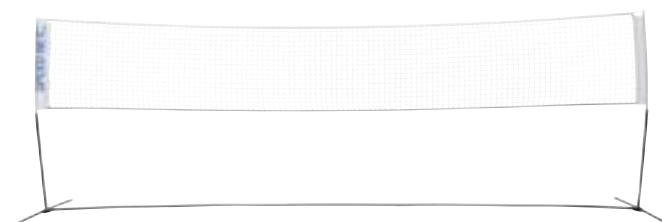

**KUIMA**  
**RETE BADMINTON SPEEDNET 500**

Cod. MePA [8490708](#)



**KUIMA**  
**RETE BADMINTON EASY NET 5 M**

Cod. MePA [8551873](#)



**KUIMA**  
**RETE BADMINTON EASY NET 3 M**

Cod. MePA [8739847](#)



**KUIMA**  
**OVERGRIP BADMINTON**  
**SUPERIOR**

Cod. MePA [8552141](#)

# GINNASTICA

A young boy with dark hair, wearing a red t-shirt and black shorts, is performing a handstand on a wooden ladder in a gym. He is smiling and has his arms extended horizontally. The ladder is made of light-colored wood and is positioned against a wall of vertical wooden planks. In the background, there are some gym equipment items, including a black bag and a water bottle on a bench, and a stack of three wooden blocks on the floor. The entire scene is bathed in a warm, orange light.



**DOMYOS**  
**CORDA PER SALTARE 100**

Cod. MePA [8560956](#)



**DOMYOS**  
**STEP 100**

Cod. MePA [8530258](#)



**CORENGTH**  
**CINGHIE DA SOSPENSIONE STRAP TRAINING 100**

Cod. MePA [8559625](#)



**CORENGTH**  
**FASCE ELASTICHE 100 LIGHT 2KG TURCHESI**

Cod. MePA [8527896](#)



**CORENGTH**  
**FASCIA ELASTICA 100 MEDIUM 3KG BORDEAUX**

Cod. MePA [8527897](#)



**CORENGTH**  
**FASCIA ELASTICA 100 HARD 4KG NERA**

Cod. MePA [8527901](#)



**CORENGTH**  
**ELASTICO TRAINING BAND 15 KG**

Cod. MePA [8484819](#)



**CORENGTH**  
**ELASTICO TRAINING BAND 25 KG**

Cod. MePA [8484820](#)



**CORENGTH**  
**ELASTICO TRAINING BAND 35 KG**

Cod. MePA [8484821](#)



# GINNASTICA



**DOMYOS**  
**PALLA MEDICA 1KG**  
**DIAMETRO NERA**  
 Cod. MePA [8754973](#)



**DOMYOS**  
**PALLA MEDICA 2KG**  
**DIAMETRO NERA**  
 Cod. MePA [8754984](#)



**DOMYOS**  
**PALLA MEDICA 3KG**  
**DIAMETRO NERA**  
 Cod. MePA [8754986](#)



**DOMYOS**  
**PALLA MEDICA 4KG**  
**DIAMETRO NERA**  
 Cod. MePA [8754987](#)



**DOMYOS**  
**PALLA MEDICA 5KG**  
**DIAMETRO NERA**  
 Cod. MePA [8754988](#)



**DOMYOS**  
**TAPPETINO DF920**  
 Confezione da 4 pezzi  
 Cod. MePA [8224362](#)



**KIMJALY**  
**TAPPETINO YOGA**  
**ESSENTIAL**  
 Colore: VERDE SCURO  
 Misura: 172X58X0,4cm  
 Cod. MePA [8506526](#)



**DOMYOS**  
**TAPPETINO**  
**STRETCHING 100 S 1**  
 Misura: 40x50x0,65cm  
 Colore: NERO  
 Cod. MePA [8131781](#)



**DOMYOS**  
**TAPPETINO YOGA**  
**TONEMAT S**  
**PIEGHEVOLE**  
 Colore: AZZURRO  
 Cod. MePA [8645169](#)

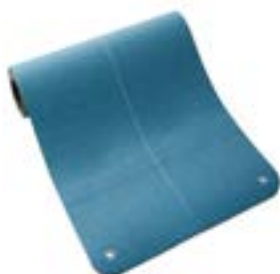

**DOMYOS**  
**TAPPETINO**  
**PIEGHEVOLE TAGLIA M**  
 Misura: 170X62X0,8CM  
 Colore: TURCHESE  
 Cod. MePA [8601545](#)



**DOMYOS**  
**TAPPETINO**  
**PIEGHEVOLE TAGLIA M**  
 Misura: 170X62X0,8CM  
 Colore: ROSA  
 Cod. MePA [8573750](#)



**CORENGTH**  
**TAPPETINO**  
**PIEGHEVOLE INDOOR**  
 Misura: 120X58cm  
 Cod. MePA [8556756](#)



**DOMYOS  
PILATES SOFTBALL**

Cod. MePA [8736370](#)



**DOMYOS  
PALLA PILATES TONING  
BALL 900G BLU**

Cod. MePA [8527927](#)



**DOMYOS  
BASTONCINO GYM  
STRETCHING 1MT**

Cod. MePA [8526538](#)



**DOMYOS  
ATTREZZO BALANCE  
SOFT DISC 100  
REVERSIBILE**

Cod. MePA [8381881](#)



**DOMYOS  
ATTREZZO BALANCE  
BOARD 500 39CM**

Cod. MePA [8343000](#)



**DOMYOS  
ATTREZZO PILATES  
RING**

Cod. MePA [8229681](#)



**DOMYOS  
ATTREZZO FITNESS  
BALANCE STATION  
900 REVERSIBILE +  
ELASTICO**

Cod. MePA [8385871](#)



**DOMYOS  
ATTREZZO PER L'EQUILIBRIO  
FITNESS REHABFEET**

Colore: grigio-verde

Cod. MePA [8645169](#)



**DECATHLON  
FOAM ROLLER 500 HARD**

Cod. MePA [8647291](#)

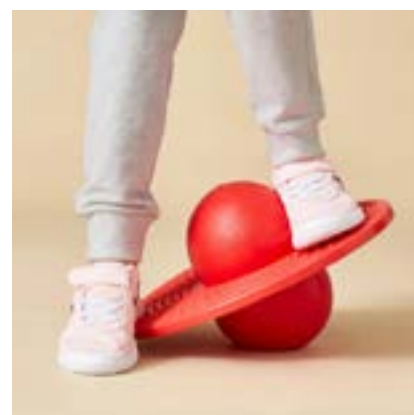

**DOMYOS  
PALLA PER L'EQUILIBRIO POGO  
BALL ROSSA + POMPA**

Cod. MePA [8733666](#)



# ■ ATLETICA







**TREMBLAY  
VORTEX 32CM**

Cod. MePA [8373763](#)



**LEGAR  
TESTIMONI**

Cod. MePA [8571078](#)



**VIVISPORT  
BLOCCO DI PARTENZA  
IN ALLUMINIO**

Cod. MePA [8356311](#)



**DECATHLON CLUB  
BLOCCO DI PARTENZA  
A 3 CEPPI**

Cod. MePA [3005](#)



**LEGAR  
OSTACOLO REGOLABILE**

Cod. MePA [8510821](#)



**VIVISPORT  
FERMAPIEDI IN LEGNO MASSICCIO**

Cod. MePA [8762766](#)



**VIVISPORT  
RITTI PER SALTO  
IN ALTO**

Cod. MePA [8571074](#)



**VIVISPORT  
PALLA GETTO  
IN GOMMA 2KG**

Cod. MePA [8753350](#)



**VIVISPORT  
PALLA GETTO  
IN GOMMA 3 KG**

Cod. MePA [8753356](#)



**VIVISPORT  
PALLA GETTO  
IN GOMMA 4 KG**

Cod. MePA [8753357](#)

# ATLETICA



**VIVISPORT**  
**PALLA GETTO**  
**IN GOMMA 5 KG**

Cod. MePA [8514389](#)



**VIVISPORT**  
**PALLA GETTO**  
**IN GOMMA 6 KG**

Cod. MePA [8753358](#)



**VIVISPORT**  
**PALLA GETTO**  
**IN GOMMA 7,26 KG**

Cod. MePA [8753360](#)



**VIVISPORT**  
**MATERASSO**  
**200X100X5 CM**

Cod. MePA [8760694](#)



**VIVISPORT**  
**MATERASSO 200X100X10 CM**

Cod. MePA [8760696](#)



**VIVISPORT**  
**MATERASSO 200X100X20 CM**

Cod. MePA [8760697](#)



**VIVISPORT**  
**MATERASSO 200X100X30 CM**

Cod. MePA [8760699](#)



**VIVISPORT**  
**MATERASSO**  
**200X100X40 CM**

Cod. MePA [8760700](#)



**VIVISPORT**  
**MATERASSO**  
**200X100X50**

Cod. MePA [8760701](#)



**VIVISPORT**  
**MATERASSO**  
**200X200X40 CM**

Cod. MePA [8760702](#)



**VIVISPORT**  
**MATERASSO**  
**200X200X50 CM**

Cod. MePA [8760704](#)



**VIVISPORT  
MATERASSO  
200X300X40 CM**

Cod. MePA [8760705](#)



**VIVISPORT  
MATERASSO  
200X300X50 CM**

Cod. MePA [8760707](#)



**DECATHLON  
CLUB  
CONO CALPESTABILE  
13 CM**

Cod. MePA [9418](#)



**DECATHLON  
CLUB  
CONO CALPESTABILE  
30 CM**

Cod. MePA [9419](#)



**DECATHLON CLUB  
ASTICELLA SEGNALIMITE IN FIBRA  
VETRO**

Cod. MePA [3613](#)



**DECATHLON CLUB  
ASTICELLA SOFT ANTITRAUMA**

Cod. MePA [3616](#)



**DECATHLON CLUB  
TESTIMONI PVC**

Cod. MePA [AB0020](#)



**KALENJI  
CRONOMETRO  
CON BASE KICK & RUN**

Cod. MePA [8584291](#)



**KALENJI  
CRONOMETRO ONSTART 500**

Cod. MePA [8603125](#)



**VIVISPORT  
OSTACOLO REGOLABILE**

Cod. MePA [8536747](#)



# ARCIERIA



**GEOLOGIC**  
**ARCO DISCOVERY 100**  
**NERO**

Cod. MePA [8505665](#)



**GEOLOGIC**  
**ARCO DISCOVERY 100**  
**VERDE**

Cod. MePA [8505666](#)



**GEOLOGIC**  
**ARCO DISCOVERY 100**  
**ROSSO**

Cod. MePA [8505667](#)



**GEOLOGIC**  
**ARCO BAMBINO**  
**DISCOVERY JUNIOR BLU**

Cod. MePA [8343722](#)



**GEOLOGIC**  
**FRECCHE TIRO CON**  
**L'ARCO DISCOFT**  
**ARANCONI X2**

Cod. MePA [8542570](#)



**GEOLOGIC**  
**FRECCHE TIRO CON**  
**L'ARCO DISCOFT**  
**VERDI X2**

Cod. MePA [8542931](#)



**GEOLOGIC**  
**CORDA ARCO**  
**DISCOVERY**  
**JUNIOR**

Cod. MePA [8390313](#)



**GEOLOGIC**  
**CORDA TIRO CON L'ARCO**  
**DISCO100**

Cod. MePA [8222987](#)



**GEOLOGIC**  
**FRECCHE DISCOVERY 100**  
**X3**

Cod. MePA [8542782](#)



**GEOLOGIC**  
**FRECCHE TIRO CON**  
**L'ARCO CLUB 500 X3**  
**CARBONIO**

Cod. MePA [8543387](#)



**GEOLOGIC**  
**FRECCHE TIRO CON**  
**L'ARCO DISCOVERY 300**  
**X3 CARBONIO**

Cod. MePA [8542572](#)



**GEOLOGIC**  
**ESTRATTORE FRECCIA**  
**TIRO CON L'ARCO**

Cod. MePA [8336925](#)



**GEOLOGIC**  
**KIT TIRO CON L'ARCO SOFTARCHERY 100**

Cod. MePA [8505629](#)



**GEOLOGIC**  
**KIT TIRO CON L'ARCO DISCOVERY 100**

Cod. MePA [8751166](#)



**GEOLOGIC**  
**MIRINO TIRO CON**  
**L'ARCO CLUB 500**

Cod. MePA [8336922](#)

# GOLF



**INESIS**  
**BASTONE REGOLABILE FIRST CLUB**  
**BAMBINO 2-13 ANNI**  
Cod. MePA [8363728](#)



**INESIS**  
**PUTTER JUNIOR 11-13 ANNI**  
Cod. MePA [8359965](#)



**INESIS**  
**PUTTING SET**  
Cod. MePA [8489473](#)





**INESIS**  
**KIT GOLF JUNIOR 11-13 ANNI DESTROSO**

Cod. MePA [8519911](#)



**INESIS**  
**PALLINA GOLF IN SCHIUMA 100**

Cod. MePA [8363181](#)



**INESIS**  
**PALLINA GOLF IN SCHIUMA 100**

Cod. MePA [8363182](#)



**INESIS**  
**KIT GOLF JUNIOR 11-13 ANNI MANCINO**

Cod. MePA [8519910](#)



**INESIS**  
**PALLINA GOLF GONFIABILE 500**

Cod. MePA [8363183](#)



**INESIS**  
**PALLINA GOLF GONFIABILE 500**

Cod. MePA [8363184](#)



**INESIS**  
**RETE PER PRATICA**

Cod. MePA [8489477](#)



**INESIS**  
**TAPPETO DI PRATICA**

Misure: 58 X 38 X 2 CM

Cod. MePA [8553747](#)



**INESIS**  
**RETE DA APPROCCIO**

Cod. MePA [8489475](#)

# ■ SCHERMA







**NASYCON**  
**MASCHERA SCHERMA**  
**BAMBINO ROSSA**

Cod. MePA [8623078](#)



**FENC'IT**  
**BORSA SCHERMA 500 VERDE/NERA**

Cod. MePA [8573081](#)



**NASYCON**  
**MASCHERA SCHERMA**  
**BAMBINO BLU**

Cod. MePA [8623077](#)



**NASYCON**  
**FIOPETTO IN PLASTICA BAMBINO**  
**NERO**

Cod. MePA [8623079](#)



**ALFAFENCING**  
**FIOPETTO COMPLETO 85DX**

Cod. MePA [8359494](#)





# FLOORBALL



**OROKS**  
**BORSA FLOORBALL FB 900**  
Cod. MePA [8558754](#)



**OROKS**  
**MAZZA FLOORBALL JR**  
Cod. MePA [8406063](#)



**BARRET**  
**SET UNIHOCKEY**  
Cod. MePA [S05134](#)



**LEGAR**  
**BASTONE HOCKEY**  
Cod. MePA [241920](#)



**OROKS**  
**PALLA FLOORBALL BIANCA**  
Cod. MePA [8405973](#)



**OROKS**  
**PALLA FLOORBALL ARANCIO**  
Cod. MePA [8405974](#)

# TCHOUKBALL



**WESPORT**  
**PALLONE TCHOUKBALL WESPORT**  
**PRO, TAGLIA 2**

Cod. MePA 8808639



**WESPORT**  
**PALLONE TCHOUKBALL WESPORT**  
**TRAINING, TAGLIA 2**

Cod. MePA 8808602



**WESPORT**  
**PALLONE TCHOUKBALL WESPORT**  
**TRAINING, TAGLIA 1**

Cod. MePA 8807684



**ATORKA**  
**PORTA TCHOUKBALL HTK 500**

Cod. MePA [8497539](#)

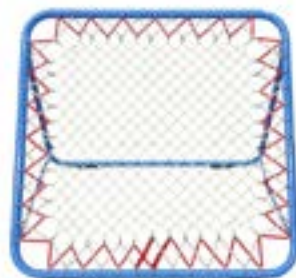

**WESPORT**  
**PANNELLO DA TCHOUKBALL**

Cod. MePA [8793126](#)





# JUDO / KARATE







**VIVISPORT**  
**SAGOMA GONFIABILE IN PVC/PU H. CM.175**  
 Cod. MePA [8812153](#)

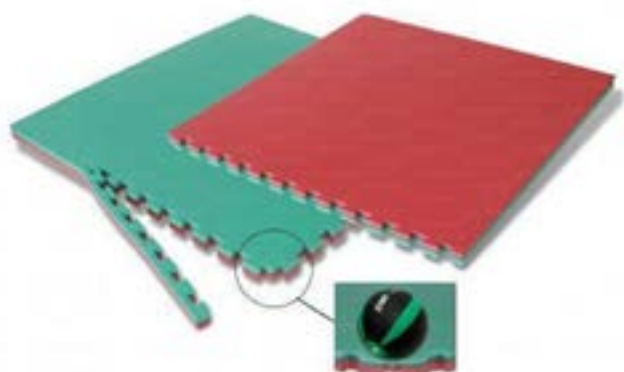

**VIVISPORT**  
**TAPPETO INCASTRO 2 CM**  
 Cod. MePA [8514394](#)

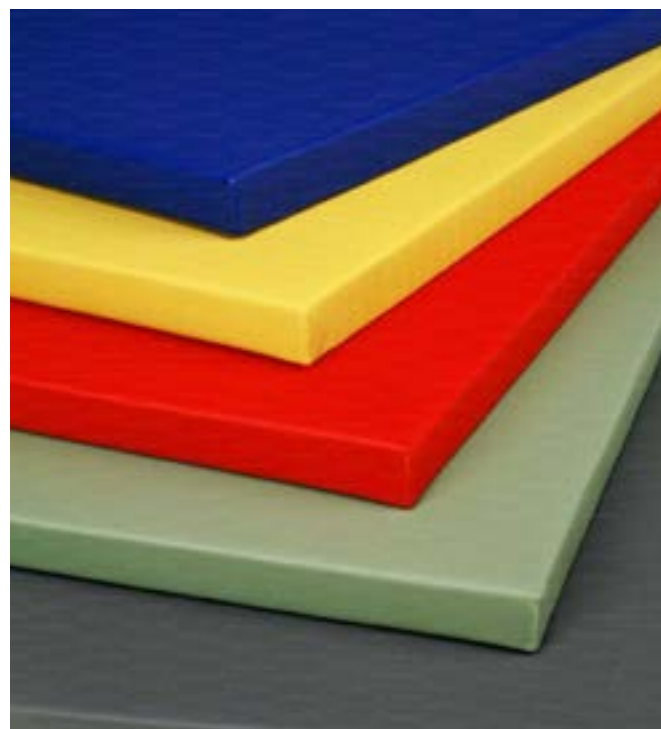

**VIVISPORT**  
**TATAMI JUDO IJT LISCIO**  
 Cod. [MePA 8598035](#)

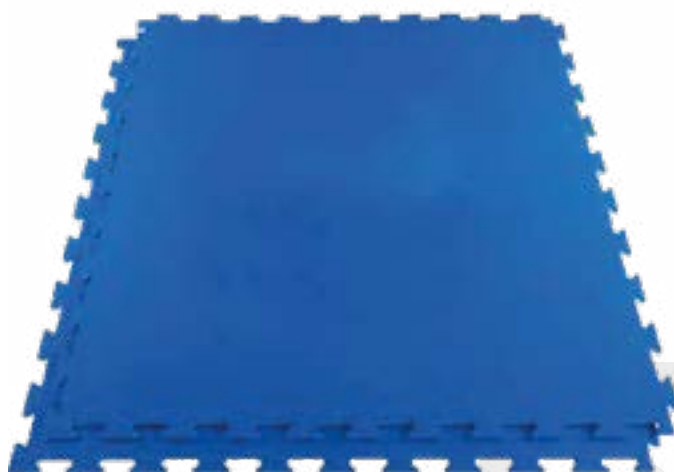

**VIVISPORT**  
**TATAMI AD INCASTRO IN EVA CM.100X100X1 COLORE BLU**  
 Cod. [MePA 8832492](#)

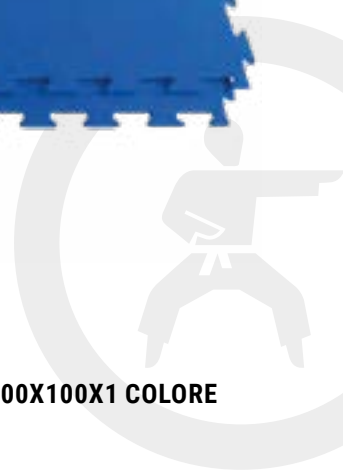

# MATERIALE ALLENAMENTO

A photograph of three children training on a green artificial turf field. The child in the foreground is wearing a light green long-sleeved shirt and dark pants, stepping on an orange cone. Two other children are visible in the background, also on the field. A soccer goal is on the left, and palm trees and hills are in the background. The entire image has a warm orange tint. The text 'MATERIALE ALLENAMENTO' is overlaid in large white letters.



**KIPSTA**  
**PETTORINA ADULTO**

Cod. MePA [8526946](#)



**KIPSTA**  
**PETTORINA JR**

Cod. MePA [8526956](#)



**KIPSTA**  
**PETTORINA REVERSIBILE 1**

Cod. MePA [8542229](#)



**KIPSTA**  
**SCALA DA ALLENAMENTO**  
**MODULABILE**

Colore: ARANCIONE

Cod. MePA [8552079](#)



**KIPSTA**  
**SCALA DA ALLENAMENTO**  
**ESSENTIAL**

Cod. MePA [8496478](#)



**KIPSTA**  
**OSTACOLO VELOCITÀ 3 ALTEZZA**

Cod. MePA 8776316



**KIPSTA**  
**CONFEZIONI 4 CONI**  
**ESSENTIAL**

Cod. MePA [8547467](#)



**KIPSTA**  
**CONFEZIONE 6 CONI**  
**ESSENTIAL 15 CM**  
**ARANCIONI**

Cod. MePA [8496475](#)



**KIPSTA**  
**CONFEZIONE 6 CONI**  
**ESSENTIAL 15 CM**  
**GIALLI**

Cod. MePA [8496474](#)



**KIPSTA**  
**ESAGONO UNIVERSALE**

Misura: 58CM

Cod. MePA [8350553](#)



# MATERIALE ALLENAMENTO



**KIPSTA**  
**FISCHIETTO A PERA**

Cod. MePA [8100420](#)



**KIPSTA**  
**FISCHIETTO IN PLASTICA**

Cod. MePA [8027254](#)



**KIPSTA**  
**CONFEZIONE 40 COPPETTE ESSENTIAL**

Colori: giallo, arancione, grigio e blu

Cod. MePA [8497806](#)



**LEGAR**  
**KIT CONI**

Altezza: 30 cm

Cod. MePA [8527351](#)



**KIPSTA**  
**CONFEZIONE 2 PICCHETTI MODULATI**

Misura: 50 cm

Cod. MePA [8496468](#)



**BARRET**  
**CONFEZIONE 48 DELIMITATORI**

Altezza: 5 cm con rimessaggio

Cod. MePA 8847919



**VIVISPORT**  
**TRAMPOLINO ELASTICO**

Cod. MePA [8762729](#)



**KIPSTA**  
**POMPA PER PALLONI ESSENTIAL**

Cod. MePA [8556016](#)



**BARRET**  
**COMPRESSORE ELETTRICO**

Potenza: 220 / 12 Volt

Cod. MePA 8400194



**PHYTO PERFORMANCE**  
**BORSA MEDICA SPORTIVA 2 PEZZI**

Cod. MePA [8619971](#)



**OFFLOAD  
GHIACCIO ISTANTANEO**

Cod. MePA [8306012](#)



**OFFLOAD  
BORSA DEL GHIACCIO**

Taglia: L  
Cod. MePA [8577826](#)



**PHYTO  
PERFORMANCE  
GHIACCIO ISTANTANEO**

32 pezzi  
Cod. MePA [8619974](#)



**PHYTO  
PERFORMANCE  
GHIACCIO SPRAY**

12 pezzi  
Cod. MePA [8619973](#)



**KIPSTA  
POMPA DOPPIA AZIONE  
CON MANOMETRO NERA**

Cod. MePA [8365293](#)



**TREMBLAY  
CONFEZIONE 3  
PICCHETTI SLALOM  
GIALLO-ROSSO**

Cod. MePA [5899638](#)



**TREMBLAY  
PICCHETTO SLALOM  
CON BASE**

Cod. MePA [8403861](#)



**BARRET  
CONO FORATO ALT. 50  
CM CON 16 FORI**

Cod. MePA [8762913](#)



**KIPSTA  
DELIMITATORI CAMPO  
ESSENTIAL**

Colore: giallo-blu  
Cod. MePA [8496617](#)



**KIPSTA  
DISCHI PIATTI X12**

Colore: arancione-giallo  
Cod. MePA [8803492](#)



**LEGAR  
POWER SPEED  
RESISTOR**

Cod. MePA [8536251](#)



**VIVISPORT  
ROTELLA METRICA  
20 MT**

Cod. MePA [8778799](#)

SECONDARIA PRIMO GRADO

ARREDI







**ITACLUB**  
**QUADRO SVEDESE**

Cod. MePA [8762728](#)



**ITACLUB**  
**SPALLIERA SVEDESE A 2 CAMPATE**

Misura smontata: 180xH250cm

Cod. MePA [8790433](#)



**VIVISPORT**  
**ARMADIO SPOGLIATOIO METALLICO A 2 POSTI SOVRAPPosti**

Misura: 180x70x35 cm

Cod. MePA [8807695](#)



**VIVISPORT**  
**ARMADIO SPOGLIATOIO METALLICO A 3 POSTI**

Cod. MePA [8812144](#)



**VIVISPORT**  
**ATTACCAPANNI SU COLONNA CROMATO CON PORTAOMBRELLI**

Cod. MePA 9220

# ARREDI



**ITACLUB**  
**PANCA IN ACCIAIO 2 MT**  
Cod. MePA [8348646](#)



**VIVISPORT**  
**SPECCHIO**  
**ANTINFORTUNISTICO**  
**MODULARE LISCIO**  
Cod. MePA [1700](#)



**VIVISPORT**  
**CARRELLO PER**  
**TRASPORTO**  
Cod. MePA [8762719](#)



**VIVISPORT**  
**MEGAFONO**  
**AMPLIFICATO MOD.**  
**CAROL**  
Cod. MePA [8793124](#)



**ITACLUB**  
**PANCA SPOGLIATOIO SOLO SEDUTA 1 MT**  
Cod. MePA [8813884](#)



**ITACLUB**  
**PANCA SPOGLIATOIO SOLO SEDUTA 2 MT**  
Cod. MePA [8805171](#)



**ITACLUB**  
**PERTICA**  
**IN LEGNO**  
Cod. MePA [8762726](#)



**VIVISPORT**  
**SCRIVANIA IN LEGNO CON**  
**CASSETTIERA A 3 CASSETTI**  
Cod. MePA 9210



# PREMIAZIONI SPORTIVE



# PREMIAZIONI SPORTIVE



**COPPA CONO ORO4 H.27**  
28-2670.2  
Cod. MePA [8820393](#)



**COPPA CONO ARGENTO**  
H.27 13.062  
Cod. MePA [8820393](#)



**COPPA CONO ORO1 H.28**  
28-208.1  
Cod. MePA [8820393](#)



**COPPA ORO**  
H.19 13.444G  
Cod. MePA [8820394](#)



**COPPA ARGENTO H.21** 13.161  
Cod. MePA [8820394](#)



**COPPETTA H.15** 25-290  
ORO/ARGENTO/BRONZO  
Cod. MePA [8820396](#)



**LOTTO 3 COPPE ARGENTO**  
43-127.3.4.5  
Cod. MePA [8820388](#)



**LOTTO 3 COPPE ORO E ARGENTO**  
35-1032.1.2.3  
Cod. MePA [8820384](#)



**LOTTO 3 COPPE ORO**  
38-1103.5.4.3  
Cod. MePA [8820385](#)



**LOTTO 3 COPPE SILVER**  
11.143.4.5S  
Cod. MePA [8820389](#)



**TARGA PICCOLA**

Cod. MePA [8571107](#)



**TARGA MEDIA**

Cod. MePA [8571108](#)



**TARGA GRANDE**

Cod. MePA [8571109](#)



**MEDAGLIA 35 MM**

Medaglia con sticker sport o 1-2-3 posto – oro/argento/bronzo + laccetto tricolore/blu  
Cod. MePA [8534172](#)



**MEDAGLIA 50 MM**

Medaglia con sticker sport o 1-2-3 posto – oro/argento/bronzo + laccetto tricolore/blu  
Cod. MePA [8524315](#)



**MEDAGLIA 70 MM VITTORIA**

Oro/argento/bronzo + laccetto tricolore/blu  
Cod. MePA [8533241](#)



**MEDAGLIA 35 MM**

Medaglia personalizzabile fronte retro oro/argento/bronzo con cordino tricolore/blu  
Cod. MePA [8533942](#)



**MEDAGLIA 50 MM**

Medaglia personalizzabile fronte retro oro/argento/bronzo con cordino tricolore/blu  
Cod. MePA [8533940](#)



**MEDAGLIA 70 MM**

Medaglia personalizzabile fronte retro oro/argento/bronzo con cordino tricolore/blu  
Cod. MePA [8533943](#)

# CONTENITORI







**DECA CLUB**  
**CONTENITORE APERTO PIEGHEVOLE**

Cod. MePA [402](#)



**DECA CLUB**  
**CONTENITORE CHIUSO GRANDE**

Cod. MePA [1044](#)



**DECA CLUB**  
**CONTENITORE CHIUSO PIEGHEVOLE**

Cod. MePA [119002](#)



**DECA CLUB**  
**CARRELLO ESPOSITORE PORTA PALLONI**

Cod. MePA [1038](#)

# ADAPTED SPORT

DECEATHLON





**LAB 3.11**  
**CARROZZINA ENERGY JUNIOR**  
**(MULTISPORT)**

Cod. MePA [8656870](#)



**FELPA BAMBINO MOBILITA'**  
**RIDOTTA CON ZIP INTERA**

Colore: KAKI

Cod. MePA [8784168](#)



**FELPA BAMBINA MOBILITA'**  
**RIDOTTA CON ZIP INTERA**

Colore: BEIGE

Cod. MePA [8784154](#)



**LEGAR**  
**PALLONE SONORO CALCIO**  
**TORBALL E44**

Cod. MePA [211200](#)



**LEGAR**  
**PALLONE SONORO HANDBALL 1**  
**GOALBALL ULTES30**

Cod. MePA [8765523](#)



**PANTALONI BAMBINO MOBILITA'**  
**RIDOTTA CON ZIP INTERA**

Colore: KAKI

Cod. MePA [8784169](#)



**PANTALONI BAMBINA MOBILITA'**  
**RIDOTTA CON ZIP INTERA**

Colore: BEIGE

Cod. MePA [8784167](#)



# ABBIGLIAMENTO PERSONALIZZABILE



## T-SHIRT R6554 BEAGLE

T-shirt manica corta, girocollo con collo doppio elastane. Taglie: 1/2 ANNI - 4XL.  
Composizione: 100% cotone, single jersey, 155 g/m<sup>2</sup>.



## FELPA CAPPUCCIO FULL ZIP R6421 MONTBLANC

Felpa stile casual con cappuccio. Cerniera lunga. Tasca a canguro. Polsini e girovita in costina 2x2 di elastane. Taglie: 3/4 ANNI - 3XL. Composizione: 50% cotone / 50% poliestere, interno felpato, 280 g/m<sup>2</sup>.



## POLO R6638 STAR

Polo uomo manica corta. Cuciture coperte e rinforzate al collo. Orletatura sulle maniche e collo a coste. Taglie: 1/2 ANNI - 4XL  
Composizione: 100% cotone, piquet, 200 g/m<sup>2</sup>.



## FELPA CON CAPPUCCIO R1087 CAPUCHA

Regolabile. Tasche a marsupio. Collo, polsini e girovita in costina 1x1 con elastane. Modello bambino senza cordone. Taglie: 3/4 ANNI - 3XL.  
Composizione: 50% cotone / 50% poliestere, interno felpato, 280 g/m<sup>2</sup>.



- 01 02 04 05 07 08 15 16
- 19 22 23 24 25 26 30 34
- 36 37 38 46

**FELPA GIROCOLLO R1070 CLASSICA**

Felpe classica girocollo. Girocollo, polsini e girovita di elastane in costina 1x1. Copricuciture sul collo. Taglie: 1/2 ANNI - 3XL. Composizione: 50% cotone / 50% poliestere, interno felpato, 280 g/m².



- 01 07 19 21 27 31 44

**PETTORINE UNISEX R0414 AJAX**

Taglie: 8 ANNI - XL. Composizione: 100% poliestere piquet, 140 g/m².



**CAPPELLINO BS600**

Berretto a 5 pannelli con chiusura in velcro, fascia anti-sudore in poliestere, occhielli cuciti, pannello frontale rigido, visiera precurvata. Taglia unica. Composizione: 100% Cotone. 100% Poliestere per i colori Fluo



- AR AZ BI BL FX GI NE
- RO RS RY VE VL WA WB
- WG WR WV WY WZ

**SACCA - ZAINO PG280**

Zaino multiuso in nylon. Doppia corda di chiusura, rinforzo negli angoli in contrasto. Misure: 33 x 45 cm. Composizione: 100% nylon.



- 01 05 17 04 09

**BORRACCIA ALLUMINIO BS890**

100% alluminio. Borraccia con tappo a vite e moschettone in alluminio. Capacità: 500 ml. Non isoterma. Può contenere bevande calde. Dimensioni: H 21 cm Diametro 6 cm.1

**DECATHLON CLUB**  
PER LA TUA SCUOLA

**CON I pon**  
**TI AIUTIAMO NOI:**  
**REALIZZA E**  
**PERSONALIZZA!**

Decathlon è vicino ai bisogni delle scuole italiane e ha costruito un'offerta apposita dedicata ai materiali e all'abbigliamento personalizzabile con i loghi ufficiali PON

# SCOPRI I PROGETTI GRATUITI DEDICATI A TE E AI TUOI STUDENTI: VAI SULLA PAGINA DECATHLON CLUB, SEZIONE SCUOLA, PROGETTI EDUCATIONAL



**FIND YOUR SPORT:**  
il nostro claim, il tuo obiettivo  
**INQUADRA IL QR CODE**

**Aiuta i tuoi studenti a conoscersi attraverso la pratica sportiva**

## **CHIAMA ALL'APPELLO TUTTI GLI SPORTIVI: LO SPORT É SEMPRE UNA BELLA LEZIONE!**

Il tema della mobilità sostenibile nelle aree urbane, periurbane e metropolitane rappresenta una questione complessa e articolata, che richiede un'attenzione continua.

All'interno del panorama complessivo della mobilità delle persone, si possono individuare alcune categorie di spostamento che definiamo convenzionalmente "sistematici", cioè che si verificano con cadenza regolare, scandendo la nostra giornata e diventando uno dei punti fermi della quotidianità. Ne sono un esempio gli spostamenti Casa - Scuola.

Gli spostamenti sistematici, grazie alle loro caratteristiche, possono essere analizzati e studiati per essere ottimizzati attraverso interventi organizzativi e gestionali. Deve essere, altresì, considerato che oltre alla qualità della vita, dell'aria e del traffico è importante valutare il fattore economico.

È in questo contesto che gli spostamenti Casa - Scuola rappresentano un ruolo cruciale nello sviluppo di una mobilità sostenibile per l'intera città.

Decathlon si riconosce nei valori di una mobilità sostenibile attiva, in particolare nell'utilizzo della bicicletta e della camminata. Mobilità attiva utile non solo alla riduzione di emissioni e di congestione del trasporto su strada, ma anche per tutte le esternalità socio-economiche positive associate al suo utilizzo, in un qualsiasi contesto urbano come l'allentamento della congestione stradale, la riduzione dell'inquinamento acustico, il risparmio di carburante ed i benefici per la salute conseguenti ad un'attività fisica.

Per contribuire all'incremento di una mobilità sostenibile e attiva, Decathlon offre alle scuole progetti formativi per qualsiasi fascia d'età, grazie alla collaborazione di diverse realtà sportive locali e la presenza di tecnici specializzati.

Vi è la possibilità di sviluppare progetti sulla mobilità rivolti ai più piccoli, finalizzati all'apprendimento dell'uso della bicicletta ed alle nozioni base del suo funzionamento.

Vi è anche la possibilità di sviluppare laboratori di manutenzione base o corsi didattici a distanza per apprendere le norme del codice della strada e di buon utilizzo della bicicletta, dedicati allo sviluppo dell'autonomia e della confidenza con il proprio mezzo a due ruote.

*Matteo Magnoni*  
*Mobility Manager Decathlon Italia*





# POSSIAMO ESSERE IL TUO PARTNER IDEALE PER I GIOCHI DELLA GIOVENTÙ

## VUOI PARTECIPARE AI GIOCHI DELLA GIOVENTÙ? PERCHÈ NON FARLO CON STILE ANCHE NELLA TUA DIVISA?

### SCEGLI LA TUTA JOMA O GIVOVA OPPURE REALIZZA LA TUTA CHE PREFERISCI GRAZIE AI NOSTRI PRODOTTI SUBLIMATI



#### **TUTA SUBLIMATA**

Felpa senza cappuccio  
completamente personalizzabile,  
vestibilità regular, modello unisex  
TESSUTO NON ELASTICIZZATO  
COMPOSIZIONE: 100% POLYESTERE 220 GR.

## SCEGLI LA CARTA SCUOLA PIÙ ADATTA ALLE TUE ESIGENZE: **È SEMPLICE ED È GRATUITA!**

CARTA SCUOLA  
**BASIC**



CARTA SCUOLA  
**BASIC**

ACCUMULO PUNTI  
E BUONI  
TRAMITE ACQUISTI  
DIRETTI  
E DEI PROPRI  
AFFILIATI



CARTA SCUOLA  
**GOLD**

ACCUMULO PUNTI  
BUONI PER L'ACQUISTO DI  
ATTREZZATURE  
PROGETTI EDUCATIVI SOCIALI  
GRATUITI  
CASHBACK SU OGNI ACQUISTO  
SERVIZIO SANZI

CARTA SCUOLA  
**GOLD**

LE STAD

SCUOLA  
SECONDARIA  
DI SECONDO  
GRADO



# ACCESSORI



**KIPSTA**  
**PETTORINA ADULTO**

Cod. MePA [8526946](#)



**KIPSTA**  
**PETTORINA JR**

Cod. MePA [8526956](#)



**KIPSTA**  
**PETTORINA REVERSIBILE 1**

Cod. MePA [8542229](#)



**KIPSTA**  
**SCALA DA ALLENAMENTO ESSENTIAL**

Cod. MePA [8496478](#)



**KIPSTA**  
**SCALA DA ALLENAMENTO MODULABILE**

Cod. MePA [8552079](#)



**KIPSTA**  
**CONFEZIONI 4 CONI ESSENTIAL**

Cod. MePA [8547467](#)



**KIPSTA**  
**CONFEZIONI 6 CONI**  
**ESSENTIAL 15 CM**

Colore: Arancione

Cod. MePA [8496478](#)



**KIPSTA**  
**CONFEZIONI 6 CONI**  
**ESSENTIAL 15 CM**

Colore: Giallo

Cod. MePA [8496474](#)



**KIPSTA**  
**OSTACOLO VELOCITA' 3 ALTEZZA**

Cod. MePA [8776316](#)



# ACCESSORI



**KIPSTA**  
**ESAGONO UNIVERSALE 58CM**  
Cod. MePA [8350553](#)



**KIPSTA**  
**FISCHIETTO A PERA**  
Cod. MePA [8100420](#)



**KIPSTA**  
**FISCHIETTO IN PLASTICA**  
Cod. MePA [8027254](#)



**KIPSTA**  
**CONFEZIONE 40 COPPETTE ESSENTIAL**  
Colori: giallo, arancione, grigio e blu  
Cod. MePA [8497806](#)



**LEGAR**  
**KIT CONI H 30**  
Cod. MePA [8527351](#)



**KIPSTA**  
**POMPA PER PALLONI**  
Cod. MePA [8556016](#)



**KIPSTA**  
**CONFEZIONE 3 AGHI PER PALLONE**  
Cod. MePA [8027171](#)



**KIPSTA**  
**POMPA PER PALLONI CON MANOMETRO**  
Cod. MePA [8365293](#)



**LEGAR**  
**MINI COMPRESSORE**  
Cod. MePA [8400194](#)



**LEGAR**  
CONTENITORE APERTO  
PIEGHEVOLE

Cod. MePA [8540662](#)



**VIVISPORT**  
CONTENITORE CHIUSO GRANDE

Cod. MePA [8511619](#)



**LEGAR**  
CONTENITORE CHIUSO  
PIEGHEVOLE

Cod. MePA [8398816](#)



**VIVISPORT**  
PERTICA IN LEGNO

Cod. MePA [8762726](#)



**VIVISPORT**  
SPALLIERA SVEDESE 1 MT

Cod. MePA [8671575](#)



**VIVISPORT**  
QUADRO SVEDESE

Cod. MePA [8762728](#)



**KIPSTA**  
SACCA PORTA 16 PALLONI

Cod. MePA [8562384](#)



**KIPSTA**  
SACCA PORTA 8 PALLONI

Cod. MePA [8562385](#)



**KIPSTA**  
RETE 10-14 PALLONI

Cod. MePA [8001768](#)

# ACCESSORI



**VIVISPORT**  
**PANCA SPOGLIATOIO SOLO SEDUTA 1 MT**

Cod. MePA [8813884](#)

---



**VIVISPORT**  
**PANCA SPOGLIATOIO SOLO SEDUTA 2 MT**

Cod. MePA [8805171](#)

---



**VIVISPORT**  
**PANCA SPOGLIATOIO CON SEDUTA, SCHIENALE, APPENDINI**

Misura: 2 mt

Cod. MePA [8799674](#)

---



**VIVISPORT**  
**PANCA IN ACCIAIO**

Misura: 2 mt

Cod. MePA [8348646](#)

---



**VIVISPORT**  
**ARMADIO METALLICO 2 POSTI**

Cod. MePA [8807695](#)

---





**KIPSTA**  
**SACCA PORTASCARPE FLUO**

Cod. MePA [8514458](#)



**KIPSTA**  
**SACCA PORTASCARPE NERA**

Cod. MePA [8612506](#)



**KUIMA**  
**BILIARDINO BF 500 DA INTERNO**  
**LEGNO PIANO GRIGIO**

Cod. MePA [8796849](#)



**OFFLOAD**  
**GHIACCIO ISTANTNEO**

Cod. MePA [8306012](#)



**OFFLOAD**  
**BORSA DEL GHIACCIO**

Taglia: L

Cod. MePA [8577826](#)



**DECATHLON CLUB**  
**GHIACCIO ISTANTNEO**

Kit 32 pezzi

Cod. MePA [8619974](#)



**DECATHLON CLUB**  
**GHIACCIO SPRAY**

Kit 12 pezzi

Cod. MePA [8619973](#)



**DECATHLON CLUB**  
**BORSA MEDICA**  
**SPORTIVA 2 PEZZI**  
**FITOPERFORMANCE**

Cod. MePA [8619971](#)



**KIPSTA**  
**BORRACCIA IGIENICA**

Cod. MePA [8556013](#)



**DECATHLON**  
**BORRACCIA 650ML**  
**NERA**

Confezione da 50 pezzi

Cod. MePA [8817661](#)

# ■ CALCIO





**KIPSTA**  
**PALLONE CALCIO IBRIDO F500**  
**TAGLIA 5 BIANCO FIFA BASIC**  
 Cod. MePA [8619218](#)



**KIPSTA**  
**PALLONE CALCIO IBRIDO F550**  
**TAGLIA 5 FIFA BASIC**  
 Cod. MePA [8619212](#)



**MOLTEN**  
**PALLONE CALCETTO MOLTEN 801X**  
**TAGLIA 4**  
 Cod. MePA [8185318](#)



**KIPSTA**  
**PALLONE CALCIO F900 TAGLIA 5**  
**FIFA QUALITY PRO**  
 Cod. MePA [8619228](#)



**KIPSTA**  
**PALLONE FUTSAL FS100 T1**  
 Cod. MePA [8545797](#)



**KIPSTA**  
**PALLONE FUTSAL FS100 T2**  
 Cod. MePA [8545796](#)



**KIPSTA**  
**PALLONE FUTSAL FS100 T3**  
 Cod. MePA [8563502](#)



**KIPSTA**  
**PALLONE FUTSAL FS100 T4**  
 Cod. MePA [8773833](#)



**KIPSTA**  
**PALLONE FUTSAL CLUB 58CM**  
 Cod. MePA [8572437](#)



# CALCIO

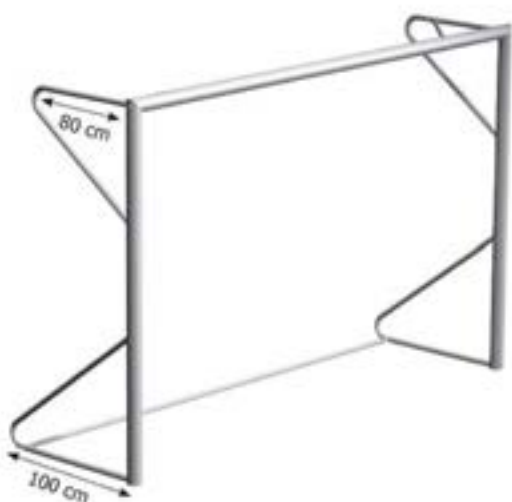

## DECATHLON CLUB

Porte 3x2 lega trasportabili

**RETI NON INCLUSE**

Cod. MePA [8762773](#)

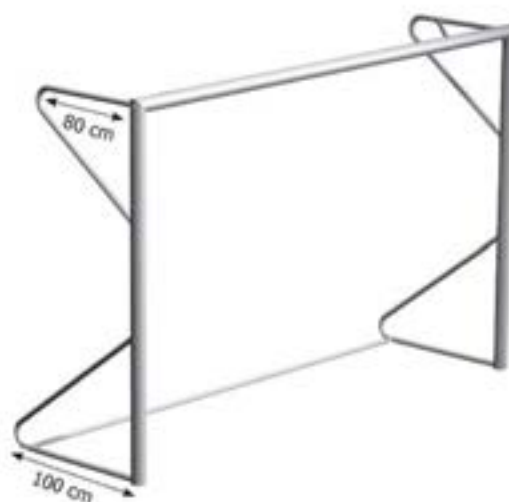

## DECATHLON CLUB

Porte 3x2 acciaio trasportabili

**RETI NON INCLUSE**

Cod. MePA [8582232](#)

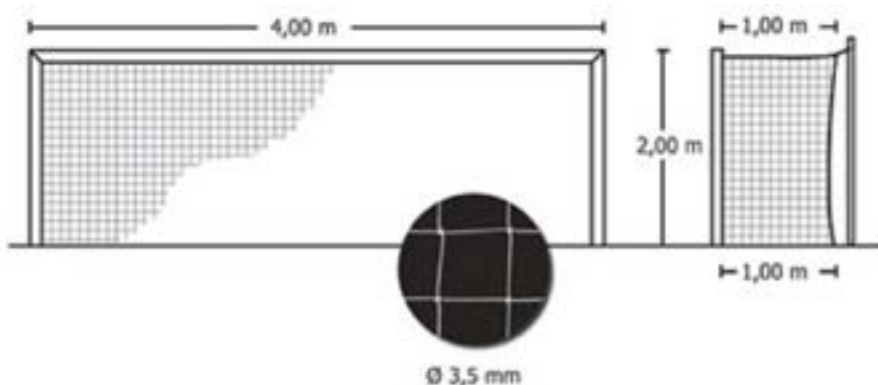

## DECATHLON CLUB

**RETE 400x200 CALCETTO QUADRA**

Cod. MePA [8409363](#)

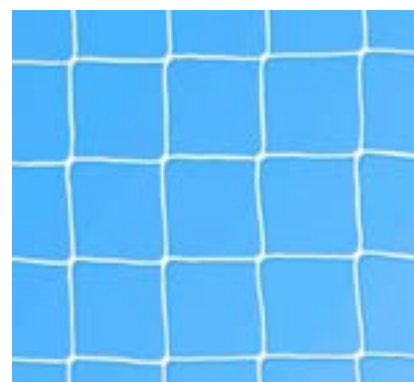

## DECATHLON CLUB

**RETE 500x200 QUADRA**

Cod. MePA [8532024](#)



## KIPSTA

**TELO PRECISIONE CALCIO SG 500  
TAGLIA M**

Cod. MePA [8526886](#)



## KIPSTA

**TELO PRECISIONE CALCIO SG 500  
TAGLIA L BASIC GOL**

Cod. MePA [8338463](#)

# PALLAVOLO

A photograph of a volleyball player in a ready stance on a court. The player is wearing a white jersey with black accents and black shorts. The court is wooden and has a net in the background. The entire image has a green color overlay. The word "PALLAVOLO" is written in large white letters across the middle of the image.

# PALLAVOLO



**ALLSIX**  
**PALLONE PALLAVOLO V100 SOFT**  
 260-280 G  
 Cod. MePA [8640987](#)



**ALLSIX**  
**PALLONE PALLAVOLO V100**  
 Cod. MePA [8604441](#)



**ALLSIX**  
**PALLONE PALLAVOLO VB500**  
 Cod. MePA [8733233](#)



**ALLSIX**  
**PALLONE PALLAVOLO V900**  
 Cod. MePA [8408660](#)



**MIKASA**  
**PALLONE PALLAVOLO V200W**  
 Cod. MePA [8570789](#)



**MIKASA**  
**PALLONE PALLAVOLO V300W**  
 Cod. MePA [8570790](#)



**MOLTEN**  
**PALLONE PALLAVOLO V5M4000**  
 TAGLIA 5  
 Cod. MePA [8132741](#)



**MOLTEN**  
**PALLONE PALLAVOLO V5M5000**  
 FLISTATEC  
 Cod. MePA [8132740](#)



**ALLSIX**  
**CARRELLI PALLONI**  
 Cod. MePA [8552382](#)





**ALLSIX  
RETE V900**

Cod. MePA [8497189](#)



**VIVISPORT  
RETE PALLAVOLO  
TRAINING**

personalizzabile

Cod. MePA [8347987](#)



**ALLSIX  
ANTENNE V900**

Cod. MePA [8408966](#)



**VIVISPORT  
ANTENNE PER RETI  
PALLAVOLO**

Cod. MePA [8347990](#)



**VIVISPORT  
BANDE MOBILI PORTA  
ANTENNE**

Cod. MePA [8348068](#)



**VIVISPORT  
SOSTEGNI PALI DA  
TERRENO**

Cod. MePA [8404344](#)



**ALLSIX  
NET TARGET**

Cod. MePA [8554277](#)



**VIVISPORT  
PALCHETTO PER ARBITRO  
RICHIUDIBILE**

Cod. MePA [8762768](#)



**VIVISPORT  
SEGNAPUNTI DA TAVOLO VOLLEY**

Cod. MePA [8400902](#)



# ■ BEACH VOLLEY



**COPAYA**  
**PALLONE BEACH-VOLLEY**  
**BV500 GIALLO-BIANCO**

Cod. MePA [8649593](#)



**COPAYA**  
**PALLONE BEACH-VOLLEY**  
**BV500 VERDE-BIANCO**

Cod. MePA [8664890](#)



**COPAYA**  
**PALLONE BEACH-VOLLEY**  
**BV500 GIALLO-BLU**

Cod. MePA [8649591](#)



**COPAYA**  
**PALLONE BEACH-VOLLEY**  
**BV900 FIVB**

Cod. MePA [8549565](#)

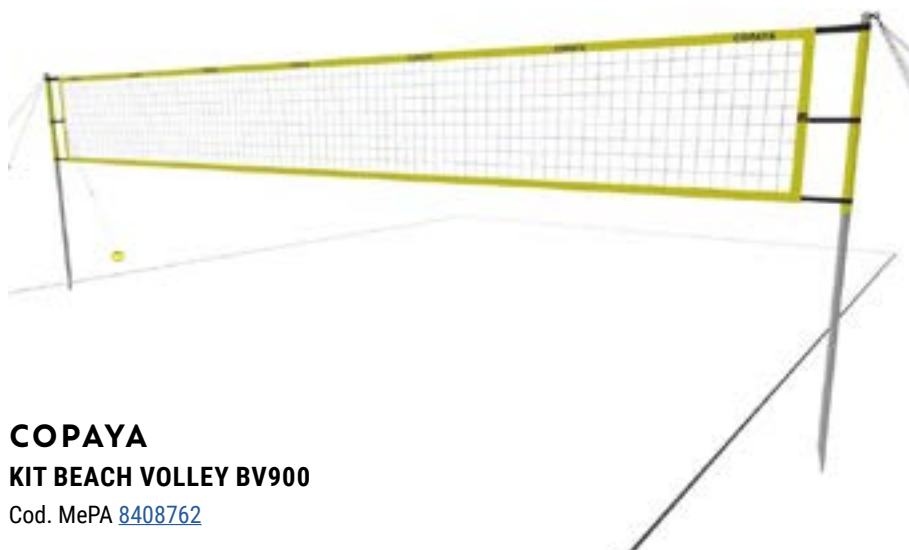

**COPAYA**  
**KIT BEACH VOLLEY BV900**

Cod. MePA [8408762](#)



**COPAYA**  
**RETE BEACH-VOLLEY BV500**

Regolabile

Cod. MePA [8480571](#)



**COPAYA**  
**DELIMITATORI DI CAMPO**  
**BEACH-VOLLEY BV900**

Cod. MePA [8408838](#)



**DECATHLON**  
**CLUB**  
**PROTEZIONI PALI**  
**BEACH VOLLEY**

Cod. MePA [8404343](#)



# PALLAMANO



**ATORKA**  
**PALLA PALLAMANO IBRIDA H500 T3**  
Cod. MePA [8669632](#)



**VIVISPORT**  
**PORTE PALLAMANO MOBILI**  
Cod. MePA [8762774](#)

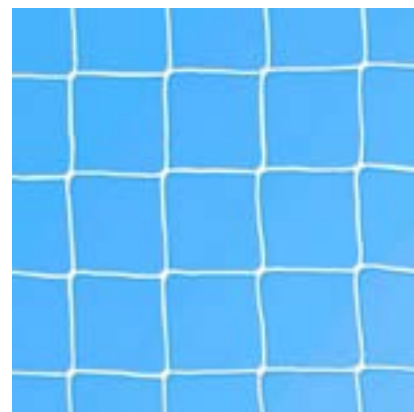

**VIVISPORT**  
**RETE 300x200 QUADRA**  
Cod. MePA [8409357](#)

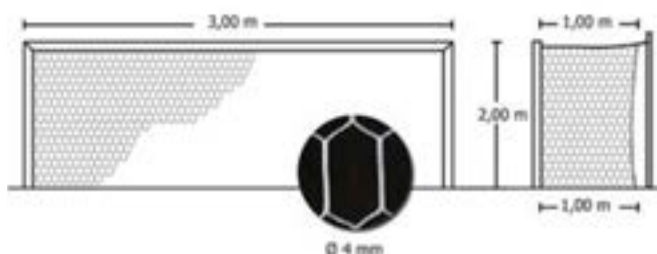

**VIVISPORT**  
**RETE 300x200 ESAGONALE**  
Cod. MePA [8762133](#)



**DECATHLON CLUB**  
**PALLONE DODGEBALL**  
Diametro cm 16  
Cod. MePA 8807756



**DECATHLON CLUB**  
**PALLONE DODGEBALL**  
Diametro cm 20  
Cod. MePA 8823518



# BASEBALL



**KIPSTA**  
**PALLE BASEBALL BA 150 X 2**

Cod. MePA [8757941](#)



**KIPSTA**  
**MAZZA BASEBALL BA 150**

Cod. MePA [8617022](#)



**KIPSTA**  
**GUANTONE BASEBALL MANO SX**

Cod. MePA [8514084](#)





# SPORT DI RACCHETTA





**KUIMA**  
**PALLINE TENNIS TB 160**  
**GIALLE X60**

Cod. MePA [8771793](#)



**BABOLAT**  
**PALLINE TENNIS BABOLAT TEAM**  
**GIALLE X4**

Cod. MePA [6054107](#)



**KUIMA**  
**PALLINE TENNIS TB930**  
**GIALLE X4**

Cod. MePA [8279042](#)



**KUIMA**  
**PALLINE TENNIS TB930**  
**GIALLE X3**

Cod. MePA [8503159](#)



**KUIMA**  
**PALLINE TENNIS TB110**  
**ARANCIONI X3**

Cod. MePA [8588569](#)



**KUIMA**  
**PALLINE TENNIS PRESSURIZZATE**  
**TB110 X3**

Cod. MePA [8573118](#)



**KUIMA**  
**PALLINE TENNIS COMFORT**  
**GIALLE X4**

Cod. MePA [8751046](#)



# SPORT DI RACCHETTA



**KUIMA**  
**SECCHIO PER PALLINE DA TENNIS**

Cod. MePA [860029](#)



**KUIMA**  
**TUBO RACCATTAPALLE**

Cod. MePA [8665678](#)



**KUIMA**  
**SACCA PER CESTO PALLINE A ROTELLE**

Cod. MePA [8641527](#)



**KUIMA**  
**CESTO PER PALLINE DA TENNIS CON ROTELLE**

Regolabile in altezza e ripiegabile.

Cod. MePA [962547](#)



**KUIMA**  
**RETE PER 10 PALLINE DA TENNIS**

Cod. MePA [8073464](#)



**KUIMA**  
**RETE PER 60 PALLINE DA TENNIS**

Cod. MePA [8013705](#)



**KUIMA**  
**RACCHETTA TENNIS ADULTO TR100 NERA**

Cod. MePA [8351925](#)



**KUIMA**  
**RACCHETTA TENNIS ADULTO TR160 AZZURRA**

Cod. MePA [8489539](#)



**KUIMA**  
**KIT TENNIS ADULTO DUO**

2 racchette 2 palline 1 fodero

Cod. MePA [8585417](#)



**KUIMA**  
**CONI DELIMITAZIONE CAMPO**  
**TENNIS**

Cod. MePA [8330435](#)



**KUIMA**  
**CONFEZIONE 6 CONI**

Altezza 190 cm e diametro 14cm

Cod. MePA [8330434](#)



**KUIMA**  
**RETE TENNIS ESSENTIAL**

Cod. MePA [8013701](#)



**KUIMA**  
**RETE TENNIS 3 METRI**

Cod. MePA [8611323](#)



**KUIMA**  
**RETE TENNIS 5 METRI**

Cod. MePA [8655756](#)



**FARRETTI**  
**RETE "SINGOLO" - M 10**

Treccia Ø mm 3,5 in polietilene senza nodo

Cod. MePA 33100008



**KUIMA**  
**MURO DA ALLENAMENTO TENNIS**

Cod. MePA [8648854](#)



**PT**  
**TAMBURELLO SONORO 28" INDOOR**

Cod. MePA [8527371](#)



# SPORT DI RACCHETTA



**KUIMA**  
**KIT 2 RACCHETTE PING PONG TTR**  
**100 3\* ALLROUND E 3 PALLINE TTB**  
**100\* 40+ ARANCIONI**  
 Cod. MePA [8528613](#)



**KUIMA**  
**RACCHETTA PING PONG**  
**PPR 130 OUTDOOR**  
 Cod. MePA [8546785](#)



**KUIMA**  
**RACCHETTA PING PONG PPR 100**  
 Cod. MePA [8286996](#)



**KUIMA**  
**RACCHETTA PING PONG PPR 130**  
 Cod. MePA [8042506](#)



**KUIMA**  
**RACCHETTA PING PONG TTR130**  
**4\* SPIN**  
 Cod. MePA [8546886](#)



**KUIMA**  
**RACCHETTA PING PONG TTR 590**  
**SPEED**  
 Cod. MePA [8612737](#)



**CORNILLEAU**  
**KIT PING PONG CORNILLEAU**  
**TACTEO 2 RACCHETTE E 3 PALLINE**  
 Cod. MePA [8808797](#)



**KUIMA**  
**PALLINE PING PONG FB830+1\*40 +**  
**BIANCHE X72**  
 Cod. MePA [8397173](#)



**KUIMA**  
**RETE PING PONG PPN 183CM**  
 Cod. MePA [131819](#)



**KUIMA**  
TAVOLO FREE PING PONG PPT 130  
MEDIUM

Cod. MePA [8563463](#)



**KUIMA**  
TAVOLO PING PONG TTT 100

Cod. MePA [2940616](#)



**KUIMA**  
TAVOLO PING PONG PPT 500.2  
OUTDOOR BLU

Cod. MePA [8583712](#)



**KUIMA**  
TAVOLO PING PONG PPT130  
OUTDOOR BLU

Cod. MePA [8558266](#)



**KUIMA**  
TAVOLO PING PONG PPT530.2  
OUTDOOR

Cod. MePA [8583715](#)



**KUIMA**  
TAVOLO PING PONG INDOOR PPT  
110

Cod. MePA [8359414](#)



**KUIMA**  
FODERO TAVOLO PING  
PONG PPC TAVOLO CHIUSO

Cod. MePA [2396968](#)



**BARRET**  
FRONT AND BACK SET

Cod. MePA [8835509](#)



**VIVISPORT**  
PALMARE IN LEGNO

Cod. MePA [8664830](#)



A photograph of three people playing badminton on a grassy field. A man in a grey shirt and dark shorts is in the center, facing the camera. To his left, a woman in a pink shirt and dark shorts is seen from the back. To his right, a woman in a white shirt and dark shorts is in a ready stance, holding a badminton racket. A net is stretched across the field. The background shows a dense forest and a building. The entire image has a green color overlay.

# BADMINTON





**KUIMA**  
**RACCHETTA BADMINTON**  
**BAMBINO BR 560 LITE**

Colore: bianca

Cod. MePA [8647934](#)



**KUIMA**  
**RACCHETTA BADMINTON JUNIOR**  
**BR500**

Colore: nero-giallo

Cod. MePA [8490826](#)



**KUIMA**  
**RACCHETTA BADMINTON ADULTO**  
**BR160**

Colore: NERO VERDE

Cod. MePA [8545288](#)



**KUIMA**  
**KIT RACCHETTE BR100 STARTER**

Cod. MePA [8758658](#)



**KUIMA**  
**RETE BADMINTON SPEEDNET 500**

Cod. MePA [8490708](#)



**VIVSPORT**  
**IMPIANTO BADMINTON**  
**REGOLAMENTARE**

Cod. MePA [8377913](#)



**KUIMA**  
**VOLANI BADMINTON FSC 930 X12**  
**VELOCITÀ 77**

Cod. MePA [8490816](#)



**KUIMA**  
**VOLANI BADMINTON OUTDOOR X3**

Cod. MePA [8212072](#)



**KUIMA**  
**DELIMITAZIONI CAMPO**  
**BADMINTON GIALLE**

Cod. MePA [8373439](#)

# BASKET





**TARMAK**  
**PALLONE BASKET RESIST 500**  
 Cod. MePA [8618565](#)



**TARMAK**  
**PALLONE BASKET BT100**  
 Cod. MePA [8495716](#)



**TARMAK**  
**PALLONE BASKET BT500**  
 Colore: BLU-ARANCIONE  
 Cod. MePA [4485521](#)



**MOLTEN**  
**PALLONE BASKET**  
 Cod. MePA [8625754](#)



**TARMAK**  
**PALLONE BASKET R100**  
 Cod. MePA [8547127](#)



**TARMAK**  
**PALLONE BASKET RESIST 500**  
 Cod. MePA [8618595](#)



**TARMAK**  
**PALLONE BASKET BT100**  
 Taglia: 7  
 Cod. MePA [8495726](#)



**TARMAK**  
**PALLONE BASKET BT500**  
 Taglia: 7. Colore: BLU - BIANCO - ROSSO  
 Cod. MePA [8614922](#)



**TARMAK**  
**PALLONE BASKET BT500 GRIP**  
 Cod. MePA [8514077](#)



# BASKET



## TARMAK

### BT 900

Taglia: 7  
Omologato FIBA per ragazzi e adulti  
Cod. MePA [8648080](#)



## SPALDING

### PALLONE BASKET TF 1000 EUROLEAGUE

TAGLIA 7  
Cod. MePA [8591171](#)



## TARMAK

### RETE BASKET 6MM

Colore: BIANCA  
Resistente alle intemperie  
Cod. MePA [8019129](#)



## TARMAK

### BORSA BASKET

Pare 5 palloni  
Cod. MePA [8407166](#)



## DECATHLON CLUB

### SEGNAPUNTI DA TAVOLO BASKET

Cod. MePA [8391181](#)



## TARMAK

### LAVAGNETTA ALLENATORE BASKET

Cod. MePA [8407150](#)



## TARMAK

### CERCHIO BASKET 500

Cod. MePA [8395749](#)



## TARMAK

### CERCHIO BASKET R900

Cod. MePA [8496975](#)



## DECATHLON CLUB

### TABELLONE ELETTRONICO

Cod. MePA [8765527](#)



**TARMAK**  
**CANESTRO BASKET B100 EASY**

Cod. MePA [8529815](#)



**TARMAK**  
**CANESTRO BASKET B100 EASY PLEXI**

Cod. MePA [8573455](#)



**TARMAK**  
**CANESTRO BASKET B700 PRO**

Cod. MePA [8529820](#)



**TARMAK**  
**CANESTRO BASKET B500**

Pieghevole

Cod. MePA [8551504](#)



**VIVISPORT**  
**MEZZO IMPIANTO MOBILE**

Cod. MePA [8396296](#)



# RUGBY



**OFFLOAD**  
**CASCO RUGBY**  
**BAMBINO E ADULTO R500**  
Cod. MePA [8576035](#)



**OFFLOAD**  
**PALLONE RUGBY R100 TRAINING**  
Taglia: 5. Colore: BLU  
Cod. MePA [8579041](#)



**OFFLOAD**  
**PALLONE RUGBY ITALIA**  
Taglia: 5  
Cod. MePA [8804086](#)





**OFFLOAD**  
**TEE RUGBY BASSO R100**

Colore: ARANCIONE  
Cod. MePA [8520077](#)



**OFFLOAD**  
**TEE RUGBY MORBIDO R100**

Colore: NERO  
Cod. MePA [8576027](#)



**OFFLOAD**  
**TEE RUGBY REGOLABILE R500**

Colore: verde militare-giallo  
Cod. MePA [8520082](#)



**OFFLOAD**  
**TEE RUGBY REGOLABILE R500**

Colore: blu-grigio  
Cod. MePA [8790168](#)



**KIPSTA**  
**CONFEZIONE 3 AGHI PER PALLONE**

Cod. MePA [8027171](#)



**KIPSTA**  
**RETE 10-14 PALLONI**

Colore: NERO-GIALLO  
Cod. MePA 8001768



**KIPSTA**  
**SACCA PER 8 PALLONI**

Colore: NERA  
Cod. MePA [8562385](#)



**OFFLOAD**  
**SCUDO DA PLACCAGGIO RUGBY R500**

Cod. MePA [8557517](#)



**OFFLOAD**  
**PETTORINA REVERSIBILE**

Colore: GIALLO-BLU  
Cod. MePA [8542229](#)



**OFFLOAD**  
**PETTORINA RUGBY R500 REVERSIBILE**

Colore: GIALLO-ARANCIONE  
Cod. MePA [8576488](#)

# ARCIERIA







**GEOLOGIC**  
**KIT TIRO CON L'ARCO**  
**DISCOVERY 100**

Cod. MePA [8751166](#)



**GEOLOGIC**  
**VISUALI TIRO CON L'ARCO**

Misura: 80 x 80 cm

Cod. MePA [8542787](#)



**GEOLOGIC**  
**CAVALLETTO TIRO CON L'ARCO**  
**CL 200**

Cod. MePA [8002636](#)



**GEOLOGIC**  
**BERSAGLIO PAGLIA**  
**TIRO CON L'ARCO**

Cod. MePA [749326](#)



**GEOLOGIC**  
**FRECCE DISCOVERY 100 X 3**

Cod. MePA [8542782](#)



**GEOLOGIC**  
**FRECCE DISCOVERY 300 X 3**

Cod. MePA [8542572](#)



**GEOLOGIC**  
**PARABRACCIO TIRO CON L'ARCO**

Cod. MePA [8753968](#)





# UNIHOCKEY / FLOORBALL

A green-tinted photograph of two floorball sticks and a ball on a dark surface. The sticks are positioned diagonally, with one in the foreground and another behind it. A ball is placed between the two sticks. The background is dark and out of focus.



**OROKS**  
**MAZZA FLOORBALL JUNIOR 100**

Cod. MePA [8406063](#)



**OROKS**  
**MAZZA FLOORBALL DESTROSO  
A-X-RED FOR**

Cod. MePA [8510795](#)



**OROKS**  
**MAZZA FLOORBALL MANCINO A-X-  
RED FOR**

Cod. MePA [8510796](#)



**OROKS**  
**PALLA FLOORBALL 500**

Colore: ARANCIO

Cod. MePA [8405974](#)



**OROKS**  
**PALLA FLOORBALL 100**

Colore: ARANCIONE

Cod. MePA [8405976](#)



**OROKS**  
**PALETTA FLOORBALL DESTROSO**

Cod. MePA [968840](#)



**DECATHLON CLUB**  
**PORTICINA HOCKEY FLORBALL**

Cod. MePA [8774997](#)



**DECATHLON CLUB**  
**KIT 5 PALLINE HOCKEY FLORBALL**

Cod. MePA [8774992](#)



**DECATHLON CLUB**  
**SET UNIHOCKEY**

Cod. MePA [8828594](#)



# ADAPTED SPORTS

La carrozzina Energy è uno strumento didattico di inclusività volto a valorizzare, all'interno della comunità scolastica, il ragazzo portatore di handicap rendendolo protagonista di attività che lo includono in un processo che coinvolge didatticamente l'intero gruppo-classe.

Il docente utilizza la carrozzina Energy non solo per e con il ragazzo disabile, ma con l'intera classe in una progettualità che vede entrambe le componenti attivamente coinvolte essendo 4 le carrozzine Energy per ogni alunno disabile motorio presente in classe che lo accompagnano per gli otto anni del Primo ciclo di Istruzione.

Tutti gli studenti, infatti, proprio per le caratteristiche dello strumento non pensato e progettato solo sulla disabilità, ma fruibile da parte di chiunque, sono coinvolti all'interno di un processo didattico inclusivo, sfidante, proattivo.

Entriamo dunque nella concretezza della didattica che si può svolgere a scuola: le attività che la carrozzina Energy permette di esperire, infatti, propongono una diversa ottica di normalità e di disabilità.

Gli schemi motori, le attività, le azioni che si possono mettere in campo prevedono la messa in gioco di tutti gli studenti che vengono chiamati ad essere fruitori della carrozzina indipendentemente dall'essere o meno disabili.

Tutti gli studenti, infatti, sono chiamati ad agire, muoversi, giocare in carrozzina, insieme, contemporaneamente.

Lo studente disabile annulla, de facto, la propria disabilità all'interno di un gruppo classe che sperimenta nuove abilità.

In questo modo possono dunque sperimentare tutti non solo la disabilità, ma la possibilità di trasformazione in una nuova abilità che necessita dell'inclusione all'interno di un gruppo.

Tutti sono abili, tutti sono diversi, tutti sono diversamente abili nell'utilizzo di Energy.

Questo nuovo e inusuale setting per la scuola, quello in cui lo studente disabile e gli studenti normodotati fanno la medesima attività in carrozzina, permette anche di lavorare in maniera sistemica sul gruppo. Si possono costruire dinamiche sfidanti, competitive oppure protette ma sempre empatiche che permettono di osservare le relazioni dei singoli, tra i singoli e sui singoli.

Ogni studente posto sulla carrozzina, infatti, mostrerà un determinato livello di abilità fisica e tecnica ma metterà in luce anche il proprio carattere e il proprio sistema valoriale. Le dinamiche tra gli studenti emergono chiare: la carrozzina è un mediatore di emozioni potente e inclusivo. Su ciascuno studente, disabile o normodotato, quindi, in un processo che ci piacerebbe potervi illustrare si possono costruire percorsi che tengano conto delle osservazioni, degli indicatori e delle competenze tecniche e relazionali che si vogliono raggiungere.

## Il Valore aggiunto

La ricaduta è duplice: da una parte il ragazzo che necessita dello strumento si trova incluso e protagonista e non ai margini dell'attività didattica e dall'altra è finalmente libero di mostrare altro di sé oltre che la propria disabilità.

Il focus, nel momento in cui si annullano le differenze fisiche, può essere dunque osservato sul suo modo di giocare, sul suo modo di agire, sulla forza di volontà, l'indole, i desideri. Indicatori che in qualunque altro contesto si farebbe fatica a mettere a tema proprio perchè le differenze coprirebbero qualsiasi tipo di osservazione.

Energy è dunque uno strumento non solo utile ma assolutamente necessario e nel contempo non solo un fine ma una grande possibilità di inclusione non solo dello studente disabile ma dell'intera comunità scolastica.

Ci auguriamo dunque di potere approfondire con Voi questi temi anche nella loro componente tecnica e organizzativa nell'ottica della costruzione di una scuola inclusiva, empatica, umana.

## Nessun timore

Energy è supportata da una piattaforma di formazione sempre attiva ed in continuo aggiornamento con setting e preset, esercitazioni ordinarie e speciali, eventi formativi in presenza.





**CARROZZINA SPORTIVA ADULTO (MULTISPORT)**

Cod. MePA [8657016](#)



**CARROZZINA BASKET REGOLABILE BW 500 26"**

Cod. MePA [8767048](#)



**CARROZZINA TENNIS E SPORT DI RACCHETTA  
REGOLABILE TW 500**

Cod. MePA [8767047](#)



**CARROZZINA ADVANTAGE (TENNIS)**

Cod. MePA [8657057](#)



**HANDBIKE REGOLABILE HB 500**

Cod. MePA [8771192](#)



# HITBALL



## **KIT HITBALL**

Kit composto da [10 protezioni](#) + [10 palloni](#)

[Visita il sito](#)

---

# KIN-BALL



**PALLONE UFFICIALE  
KIN-BALL**

Cod. MePA 8676774



**CAMERA D'ARIA  
KIN-BALL**

Cod. MePA 8676775





# ■ ATLETICA



**VIVISPORT**  
**BLOCCO DI PARTENZA A 3 CEPPI**

Cod. MePA [8764177](#)



**LEGAR**  
**OSTACOLO REGOLABILE**

Cod. MePA [8510821](#)



**VIVISPORT**  
**FERMAPIEDI IN LEGNO MASSICCIO**

Cod. MePA [8762766](#)



**VIVISPORT**  
**PALLA GETTO IN GOMMA 2KG**

Cod. MePA [8753350](#)



**VIVISPORT**  
**PALLA GETTO IN GOMMA 3 KG**

Cod. MePA [8753356](#)



**VIVISPORT**  
**PALLA GETTO IN GOMMA 4 KG**

Cod. MePA [8753357](#)



**VIVISPORT**  
**PALLA GETTO IN GOMMA 5 KG**

Cod. MePA [8514389](#)



**VIVISPORT**  
**PALLA GETTO IN GOMMA 6 KG**

Cod. MePA [8753358](#)



**VIVISPORT**  
**PALLA GETTO IN GOMMA 7,26 KG**

Cod. MePA [8753360](#)

# ATLETICA



**VIVISPORT**  
DISCO DA LANCIO IN GOMMA 1KG  
Cod. MePA [8762757](#)



**VIVISPORT**  
DISCO DA LANCIO IN GOMMA 1,5KG  
Cod. MePA [8762758](#)



**DECATHLON**  
VORTEX 32 CM  
Cod. MePA [8373763](#)



**VIVISPORT**  
DISCO DA LANCIO IN GOMMA 1,75KG  
Cod. MePA [8762759](#)



**VIVISPORT**  
DISCO DA LANCIO IN GOMMA 2 KG  
Cod. MePA [8762760](#)



**LEGAR**  
TESTIMONI PVC  
Cod. MePA [8571078](#)



**VIVISPORT**  
ASTICELLA SOFT ANTITRAUMA  
Cod. MePA [8780782](#)



**VIVISPORT**  
RITTI PER SALTO IN ALTO  
Cod. MePA [8571074](#)





**VIVISPORT**  
**MATERASSO 200 X 100 X 5 CM**

Rivestito PVC  
Cod. MePA [8760694](#)



**VIVISPORT**  
**MATERASSO 200 X 100 X 10 CM**

Cod. MePA [8760696](#)



**VIVISPORT**  
**MATERASSO 200 X 100 X 20 CM**

Cod. MePA [8760697](#)



**VIVISPORT**  
**MATERASSO 200 X 100 X 30 CM**

Cod. MePA [8760699](#)



**VIVISPORT**  
**MATERASSO 200 X 100 X 40 CM**

Cod. MePA [8760700](#)



**VIVISPORT**  
**MATERASSO 200 X 100 X 50 CM**

Cod. MePA [8760707](#)

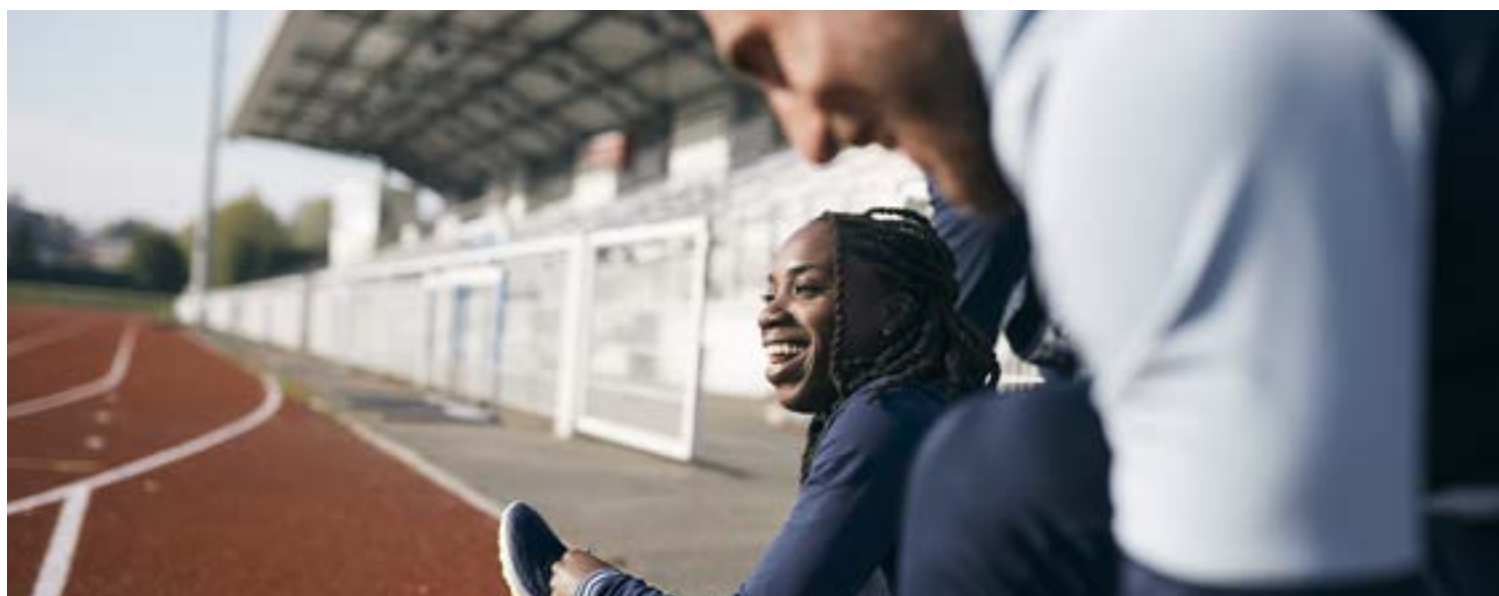

# GINNASTICA

A woman in a light blue leotard and black leggings is performing a gymnastic exercise on a beam. She is lying on her back, with her legs raised and bent at the knees, holding her feet with her hands. The background shows other people in a gymnasium, and the entire image has a green tint.



**DOMYOS**  
**CORDA PER SALTARE 500**

Cod. MePA [8560960](#)



**DOMYOS**  
**CINGHIA DA SOSPENSIONE STRAP 100**

Cod. MePA [8559625](#)



**DOMYOS**  
**STEP 100**

Cod. MePA [8530258](#)



**DOMYOS**  
**ELASTICO PILATES LIGHT**

Cod. MePA [8527896](#)



**DOMYOS**  
**ELASTICO PILATES MEDIUM**

Cod. MePA [8527897](#)



**DOMYOS**  
**ELASTICO PILATES HARD**

Cod. MePA [8527901](#)



# GINNASTICA



**DOMYOS**  
**FASCIA TRAINING 15 KG**

Cod. MePA [8484819](#)

---



**DOMYOS**  
**FASCIA TRAINING 25 KG**

Cod. MePA [8484820](#)

---



**DOMYOS**  
**FASCIA TRAINING 35 KG**

Cod. MePA [8484821](#)

---



**KIMJALY**  
**TAPPETINO YOGA ESSENTIAL**

Colore: VERDE SCURO  
Misure: 172 X 58 X 0,4 CM  
Cod. MePA [8506526](#)

---



**DOMYOS**  
**TAPPETINO YOGA TONEMAT S  
PIEGHEVOLE**

Colore: AZZURRO  
Cod. MePA [8645169](#)

---



**DOMYOS**  
**TAPPETINO STRETCHING 100 S**

Misure: 140 X 50 X 0,65 CM  
Colore: NERO  
Cod. MePA [8131781](#)

---

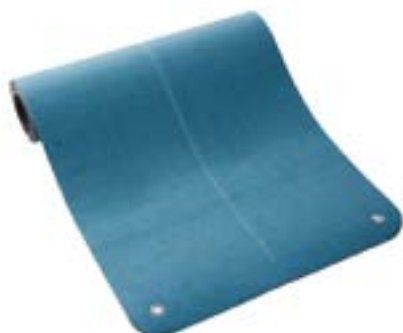

**DOMYOS**  
**TAPPETINO PIEGHEVOLE TAGLIA M**

Misure: 170 X 62 X 0,8 CM  
Colore: TURCHESE  
Cod. MePA [8601545](#)

---



**DOMYOS**  
**TAPPETINO PIEGHEVOLE TAGLIA M**

Misure: 170 X 62 X 0,8 CM  
Colore: ROSA  
Cod. MePA [8573750](#)

---



**CORENGTH**  
**TAPPETINO PIEGHEVOLE INDOOR**

Misure: 120 X 58 CM  
Cod. MePA [8556756](#)

---



## DOMYOS

### TAPPETINO DF920

CONFEZIONE DA 4 PEZZI

Cod. MePA [8224362](#)



## DECATHLON CLUB

### OSTACOLO OVER 12 CM

Cod. MePA [8816916](#)



## DECATHLON CLUB

### OSTACOLO OVER 14 CM

Cod. MePA [8817629](#)



## DECATHLON CLUB

### OSTACOLO OVER 16 CM

Cod. MePA [9917733](#)



## DECATHLON CLUB

### OSTACOLO OVER 18 CM

Cod. MePA [8817738](#)



## DECATHLON CLUB

### OSTACOLO OVER 20 CM

Cod. MePA [8817788](#)



## DECATHLON CLUB

### OSTACOLO OVER 30 CM

Cod. MePA [8817786](#)



## DECATHLON CLUB

### OSTACOLO OVER 40 CM

Cod. MePA [8817776](#)

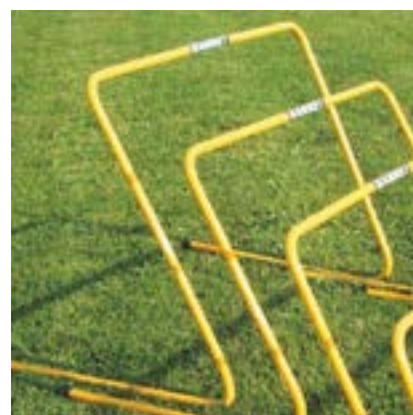

## DECATHLON CLUB

### OSTACOLO OVER 50 CM

Cod. MePA [8816917](#)

# GINNASTICA



**VIVISPORT**  
**PEDANA ELASTICA DOPPIA ARTICOLAZIONE**

Cod. MePA [8768052](#)

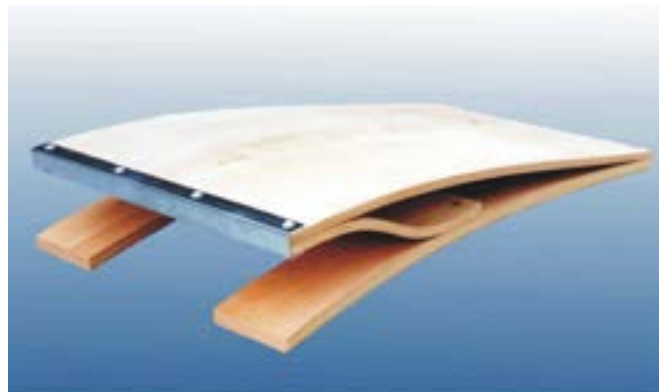

**VIVISPORT**  
**PEDANA ELASTICA TIPO REUTHER**

Piano verniciato  
Cod. MePA [8764542](#)



**VIVISPORT**  
**PEDANA ELASTICA TIPO REUTHER**

Piano in moquette  
Cod. MePA [8766740](#)



**VIVISPORT**  
**TRAMPOLINO ELASTICO**

Cod. MePA [8762729](#)



**DOMYOS**  
**PALLA MEDICA 1KG DIAMETRO**

Colore: NERA  
Cod. MePA [8754973](#)



**DOMYOS**  
**PALLA MEDICA 2KG DIAMETRO**

Colore: NERA  
Cod. MePA [8754984](#)



**DOMYOS**  
**PALLA MEDICA 3KG DIAMETRO**

Colore: NERA  
Cod. MePA [8754986](#)





**DOMYOS**  
**ATTREZZO BALANCE SOFT DISC**  
**100 REVERSIBILE**

Cod. MePA [8381881](#)



**DOMYOS**  
**ATTREZZO BALANCE BOARD 500**

Misura: 39 CM

Cod. MePA [8343000](#)



**DOMYOS**  
**PILATES SOFTBALL**

Cod. MePA [8736370](#)



**DOMYOS**  
**PALLA MEDICA 4KG DIAMETRO**

Colore: NERA

Cod. MePA [8754987](#)



**DOMYOS**  
**PALLA MEDICA 5KG DIAMETRO**

Colore: NERA

Cod. MePA [8754988](#)



**DOMYOS**  
**PALLA PILATES TONING BALL 900G**

Colore: BLU

Cod. MePA [8527927](#)

# GINNASTICA



## DOMYOS

ATTREZZO FITNESS BALANCE STATION 900 REVERSIBILE + ELASTICO

Cod. MePA [8385871](#)



## DOMYOS

BASTONCINO LEGNO GYM

Cod. MePA [8526538](#)



## DOMYOS

ATTREZZO PILATES RING

Cod. MePA [8229681](#)



## DOMYOS

ATTREZZO PER L'EQUILIBRIO  
FITNESS REHABFEET

Colore: grigio-verde

Cod. MePA [8573525](#)



## DECATHLON

FOAM ROLLER 500 HARD

Cod. MePA [8647291](#)



**NYAMBA**  
**FITBALL 55 CM BLU**  
 Cod. MePA [8603633](#)



**NYAMBA**  
**FITBALL 55 CM ROSA**  
 Cod. MePA [8640038](#)



**DOMYOS**  
**PALLA PER L'EQUILIBRIO**  
**POGO BALL**  
 Colore: rossa + pompa  
 Cod. MePA [8733666](#)



**NYAMBA**  
**FITBALL 65 CM BLU**  
 Cod. MePA [8603634](#)



**NYAMBA**  
**FITBALL 65 CM ROSA**  
 Cod. MePA [8640040](#)



**NYAMBA**  
**FITBALL 75 CM BLU**  
 Cod. MePA [8603635](#)



**NYAMBA**  
**FITBALL 75 CM ROSA**  
 Cod. MePA [8640041](#)



**NYAMBA**  
**MINI POMPA**  
 Cod. MePA [8214626](#)



# ABBIGLIAMENTO PERSONALIZZABILE

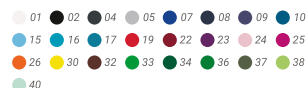

## T-SHIRT R6554 BEAGLE

T-shirt manica corta, girocollo con collo doppio elastane. Taglie: 1/2 ANNI - 4XL. Composizione: 100% cotone, single jersey, 155 g/m<sup>2</sup>.



## FELPA CAPPUCCIO FULL ZIP R6421 MONTBLANC

Felpe stile casual con cappuccio. Cerniera lunga. Tasca a canguro. Polsini e girovita in costina 2x2 di elastane. Taglie: 3/4 ANNI - 3XL. Composizione: 50% cotone / 50% poliestere, interno felpato, 280 g/m<sup>2</sup>.



## POLO R6638 STAR

T-shirt manica corta, girocollo con collo doppio elastane. Taglie: 1/2 ANNI - 4XL. Composizione: 100% cotone, single jersey, 155 g/m<sup>2</sup>.



## FELPA CON CAPPUCCIO R1087 CAPUCHA

Regolabile. Tasche a marsupio. Collo, polsini e girovita in costina 1x1 con elastane. Modello bambino senza cordone. Taglie: 3/4 ANNI - 3XL. Composizione: 50% cotone / 50% poliestere, interno felpato, 280 g/m<sup>2</sup>.



- 01 02 04 05 07 08 15 16
- 19 22 23 24 25 26 30 34
- 36 37 38 46

**FELPA GIROCOLLO R1070 CLASSICA**

Felpe classica girocollo. Girocollo, polsini e girovita di elastane in costina 1x1. Copricuciture sul collo. Taglie: 1/2 ANNI - 3XL. Composizione: 50% cotone / 50% poliestere, interno felpato, 280 g/m².



- 01 07 19 21 27 31 44

**PETTORINE UNISEX R0414 AJAX**

Taglie: 8 ANNI - XL. Composizione: 100% poliestere piquet, 140 g/m².



**CAPPELLINO BS600**

Berretto a 5 pannelli con chiusura in velcro, fascia anti-sudore in poliestere, occhielli cuciti, pannello frontale rigido, visiera precurvata. Taglia unica. Composizione: 100% Cotone. 100% Poliestere per i colori Fluo



- AR AZ BI BL FX GI NE
- RO RS RY VE VL WA WB
- WG WR WV WY WZ

**SACCA - ZAINO PG280**

Zaino multiuso in nylon. Doppia corda di chiusura, rinforzo negli angoli in contrasto. Misure: 33 x 45 cm. Composizione: 100% nylon.



- 01 05 17 04 09

**BORRACCIA ALLUMINIO BS890**

100% alluminio. Borraccia con tappo a vite e moschettone in alluminio. Capacità: 500 ml. Non isoterma. Può contenere bevande calde. Dimensioni: H 21 cm Diametro 6 cm.1

**DECATHLON CLUB**  
PER LA TUA SCUOLA

**CON I pon**  
**TI AIUTIAMO NOI:**  
**REALIZZA E**  
**PERSONALIZZA!**

Decathlon è vicino ai bisogni delle scuole italiane e ha costruito un'offerta apposita dedicata ai materiali e all'abbigliamento personalizzabile con i loghi ufficiali PON



**SCOPRI I PROGETTI GRATUITI DEDICATI A TE E AI TUOI STUDENTI:  
VAI SULLA PAGINA DECATHLON CLUB,  
SEZIONE SCUOLA, PROGETTI EDUCATIONAL**



**SPORT GENERATION  
INQUADRA IL QR CODE**

**Scegli una o più discipline e scopri tutti i loro SEGRETI!**

**CHIAMA ALL'APPELLO TUTTI GLI SPORTIVI:  
LO SPORT É SEMPRE UNA BELLA LEZIONE!**





# POSSIAMO ESSERE IL TUO PARTNER IDEALE PER LE TUE DIVISE SPORTIVE SCOLASTICHE

## REALIZZA CON NOI LA TUA DIVISA SCOLASTICA: CONOSCI GIÀ I COLORI DELLA TUA SCUOLA?

### SCEGLI LA TUTA JOMA O GIVOVA OPPURE REALIZZA LA TUTA CHE PREFERISCI GRAZIE AI NOSTRI PRODOTTI SUBLIMATI



#### **TUTA SUBLIMATA**

Felpa senza cappuccio  
completamente personalizzabile,  
vestibilità regular, modello unisex  
TESSUTO NON ELASTICIZZATO  
COMPOSIZIONE: 100% POLYESTERE 220 GR.

## SCEGLI LA CARTA SCUOLA PIÙ ADATTA ALLE TUE ESIGENZE: **È SEMPLICE ED È GRATUITA!**

CARTA SCUOLA  
**BASIC**



CARTA SCUOLA  
**BASIC**

ACCUMULO PUNTI  
E BUONI  
TRAMITE ACQUISTI  
DIRETTI  
E DEI PROPRI  
AFFILIATI



CARTA SCUOLA  
**GOLD**

ACCUMULO PUNTI  
BUONI PER L'ACQUISTO DI  
ATTREZZATURE  
PROGETTI EDUCATIVI SOCIALI  
GRATUITI  
CASHBACK SU OGNI ACQUISTO  
SERVIZIO SANDI

CARTA SCUOLA  
**GOLD**







